

NOTES:
- LIBRARY INTERIOR STAINED WOOD

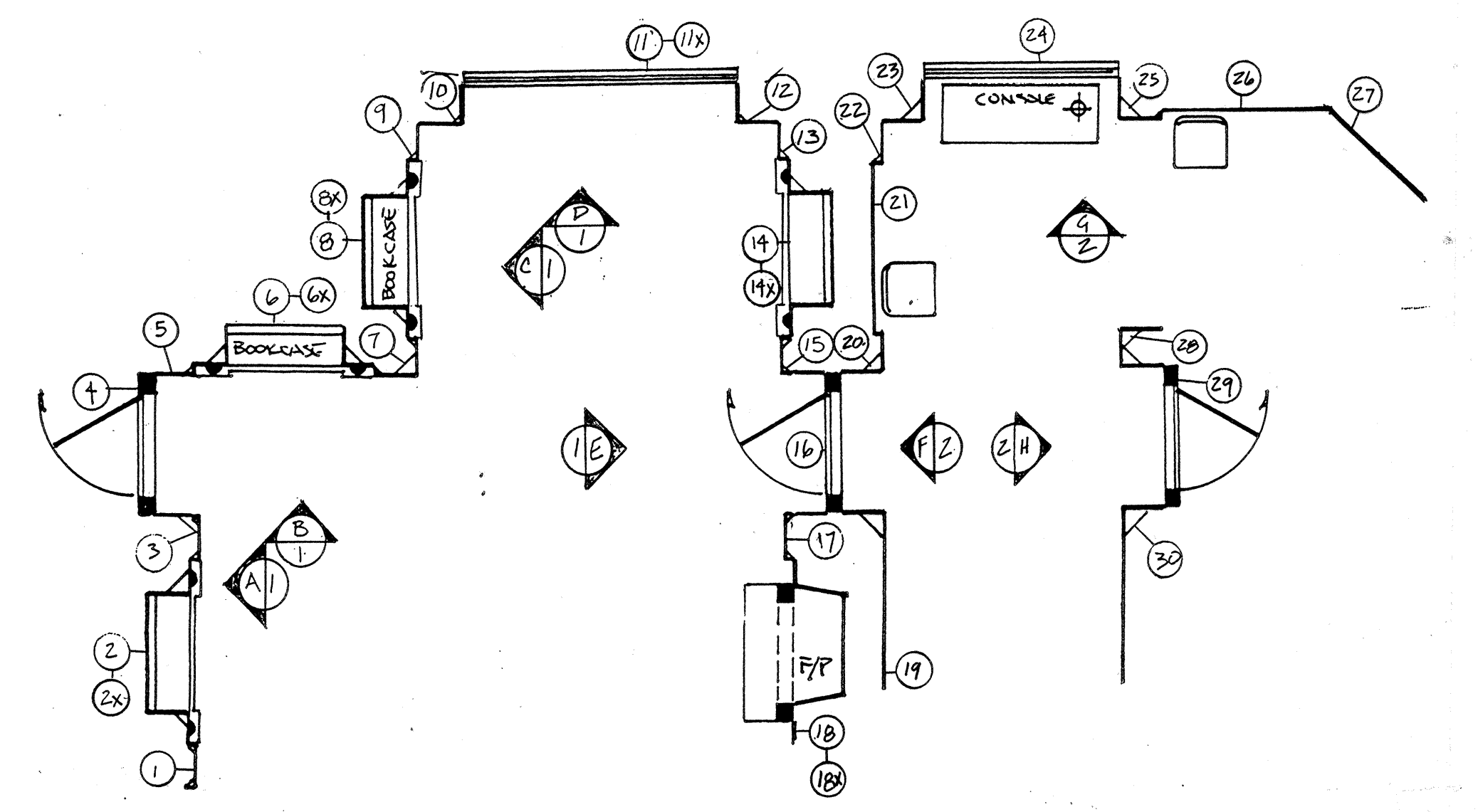

<p>S.D. 1104 SCENIC DESIGNER</p>	AMERICAN BROADCASTING COMPANIES		DRAWING NO.	
	PROD: ALL MY CHILDREN		STUDIO TV 23	
	SET: CHANDLER'S LIBRARY			
	SCALE: 1/2"=1'-0"	DEL. DATE: 2-27-02		OF 3
	DATE: 2-5-02	PROD. DATE: 2-28-02		
DESIGNER: P MOONEY		DRAFTSMAN: M FAUER		

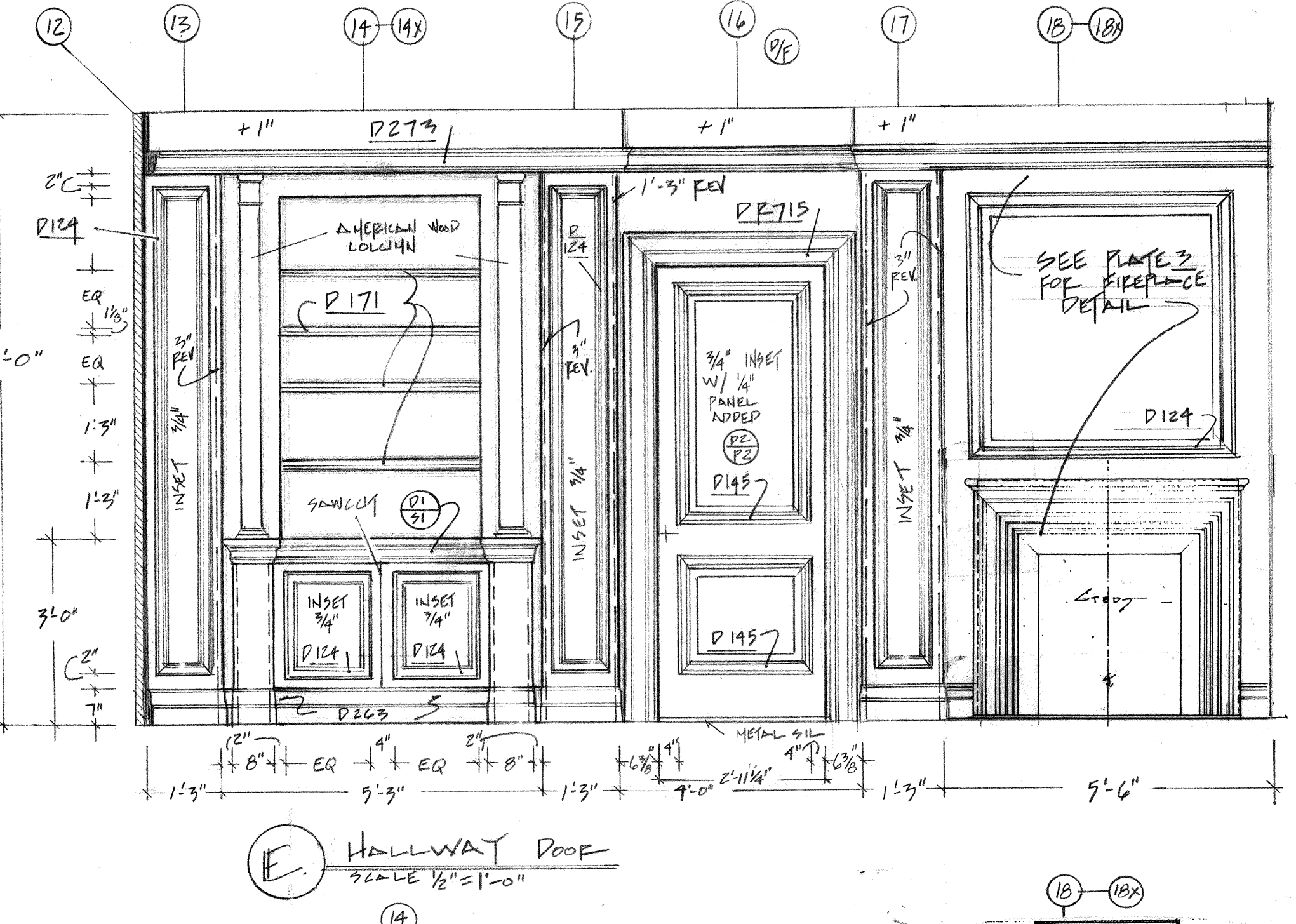
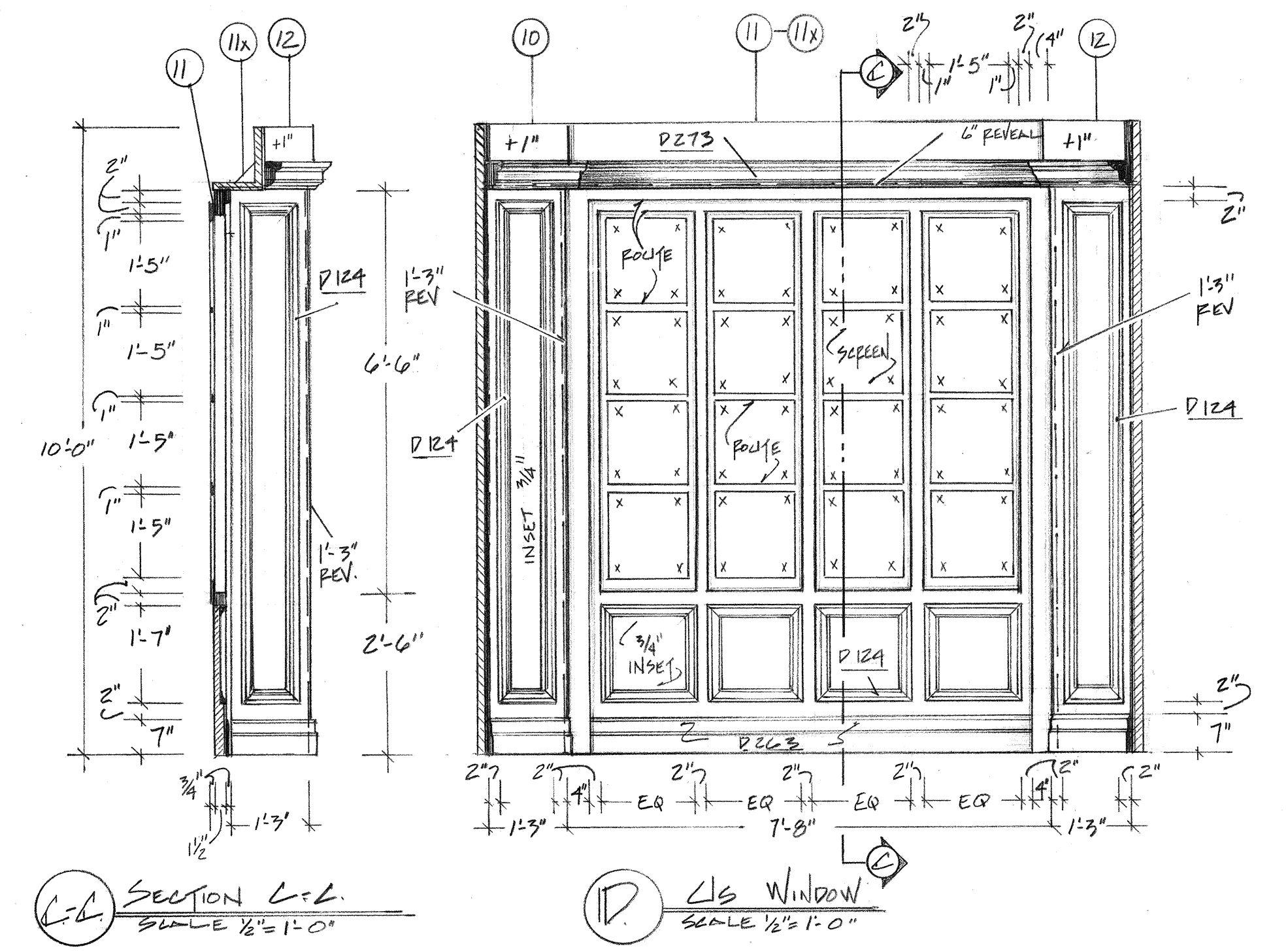
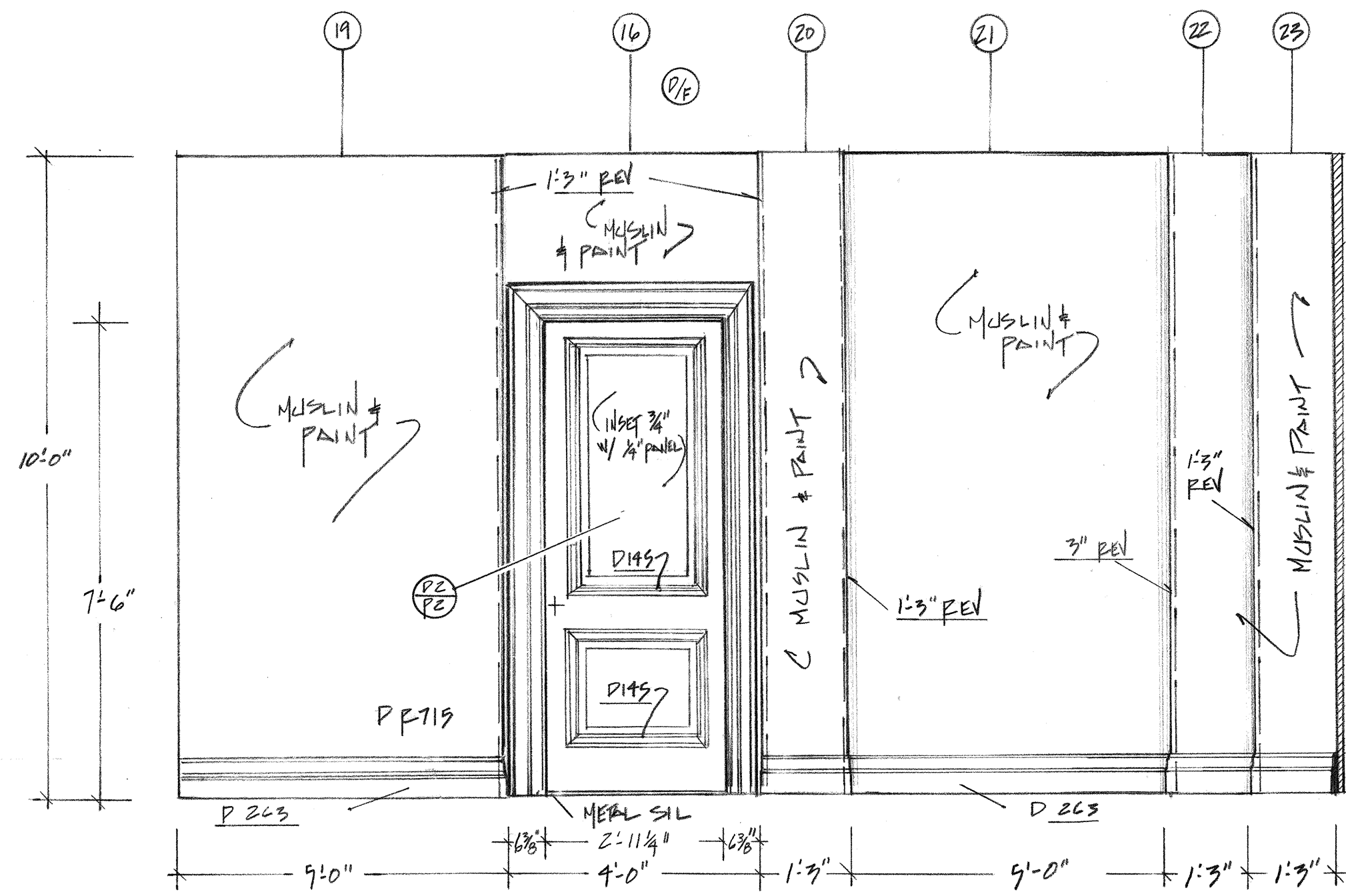

F HALLWAY SR
SCALE 1/2" = 1'-0"

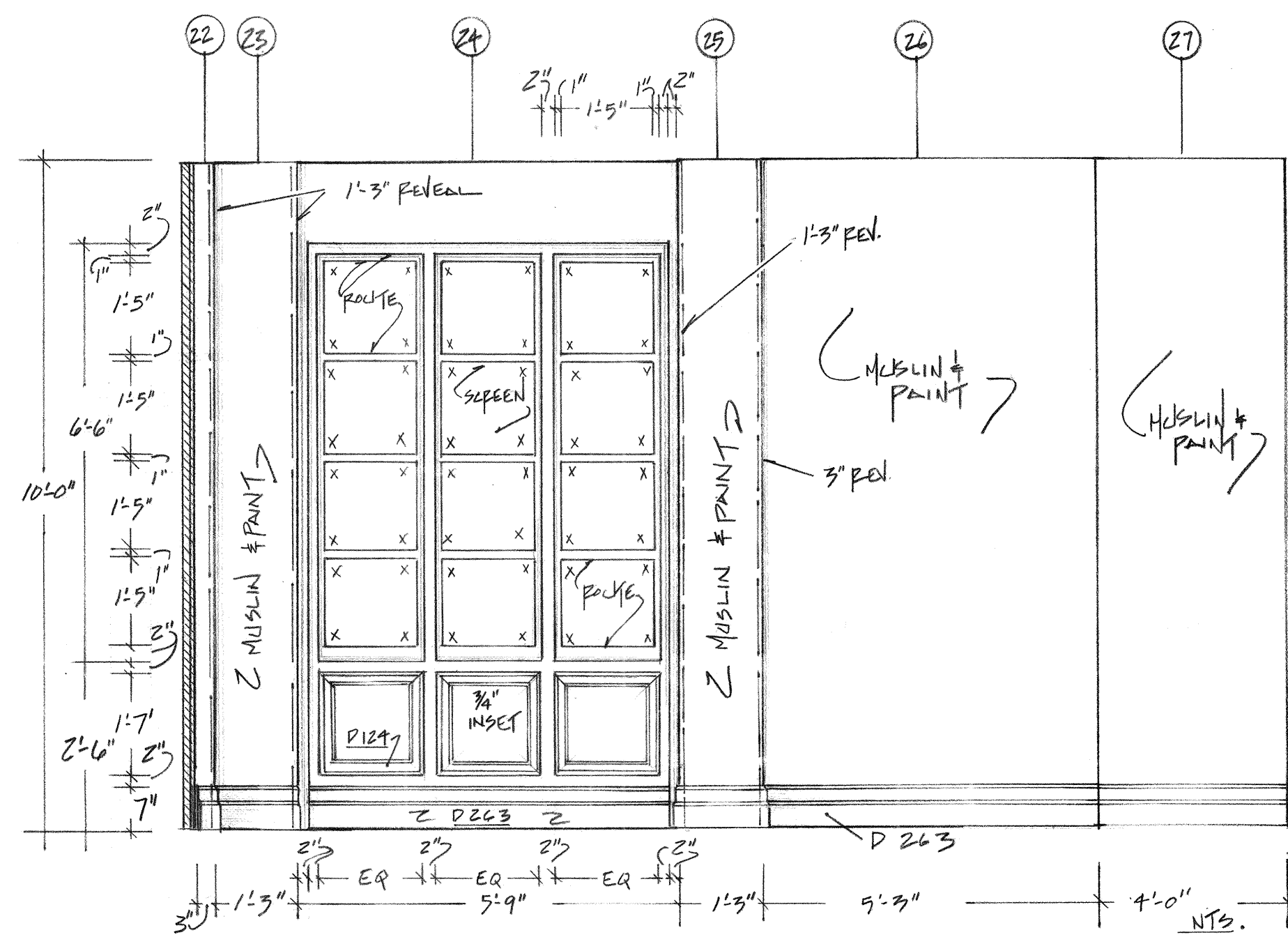
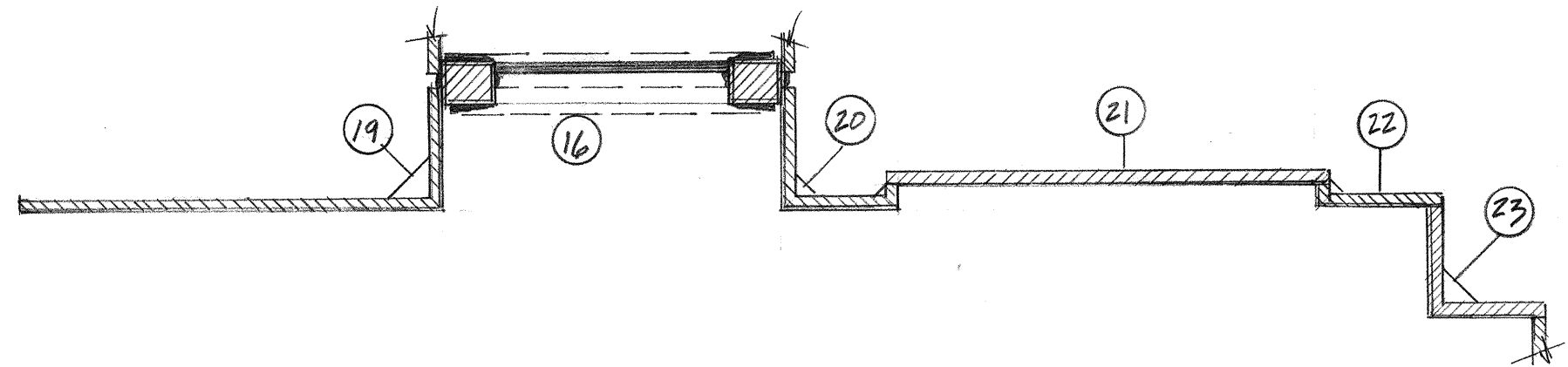

G US HALL WINDOW
SCALE 1/2" = 1'-0"

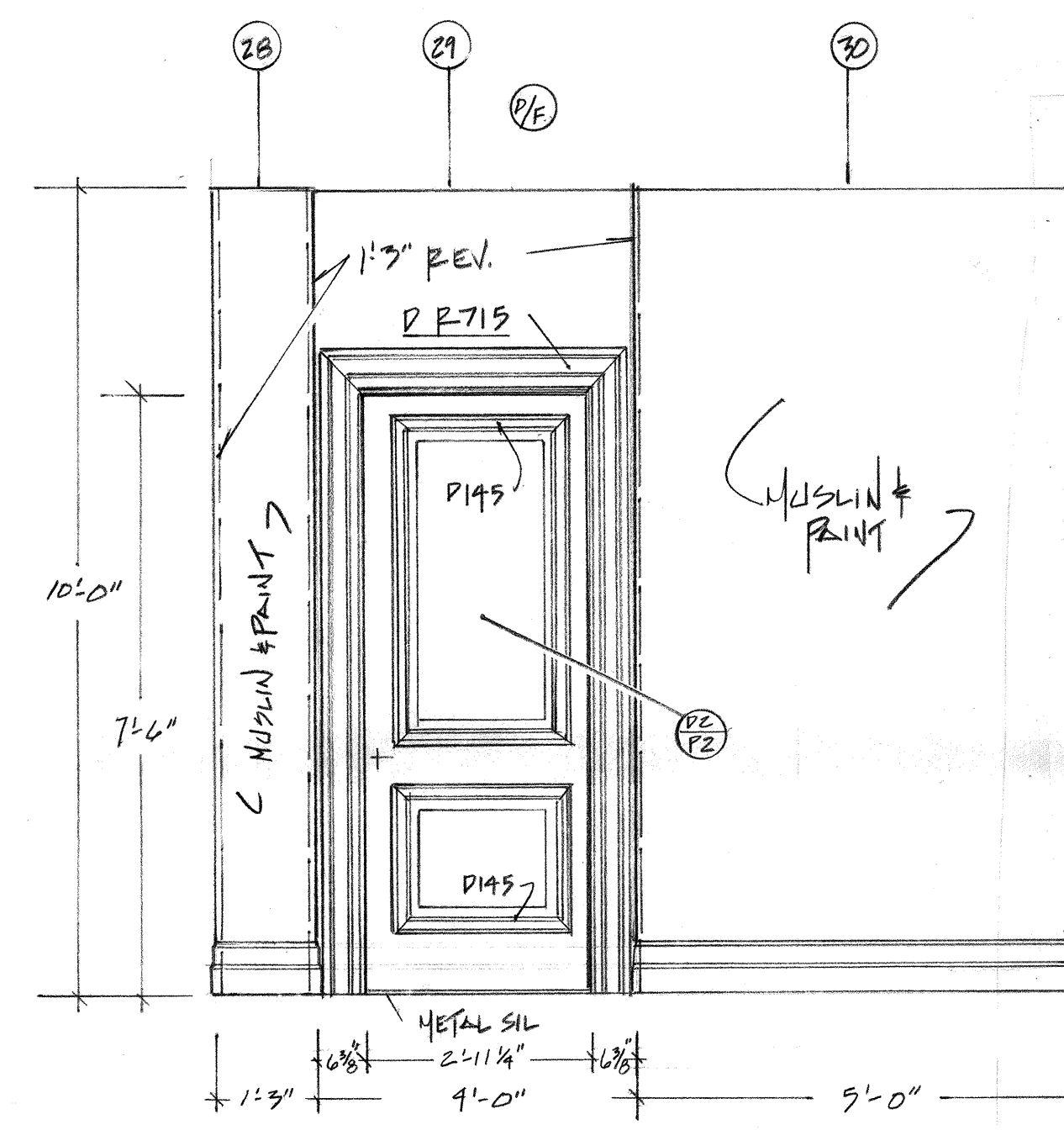
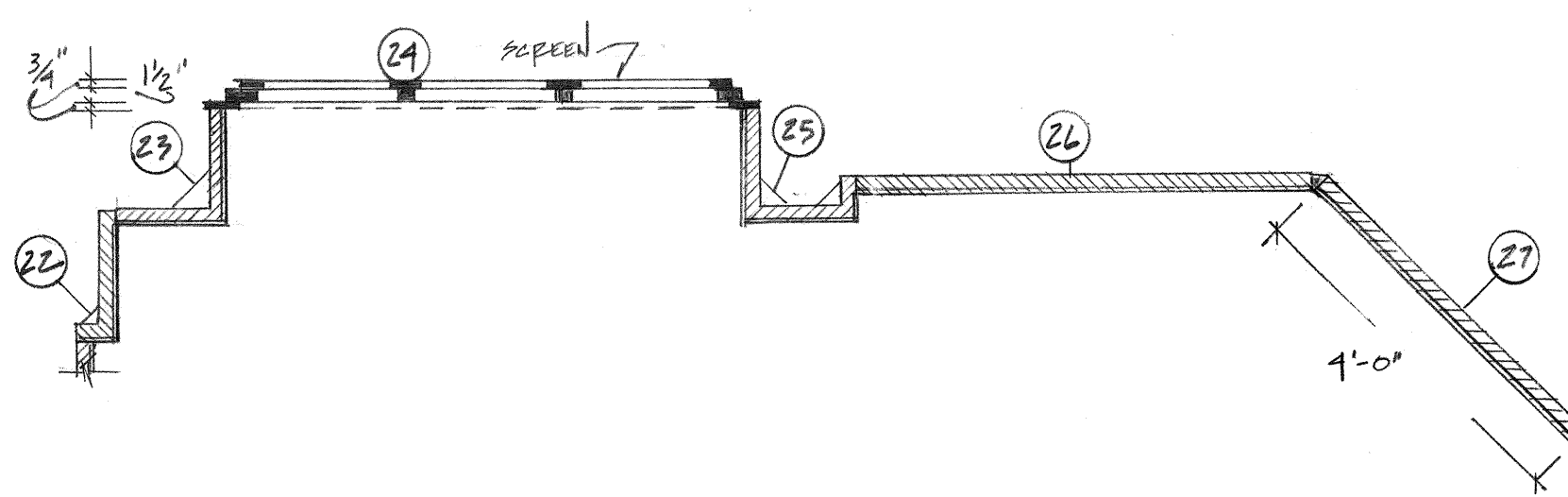

H HALLWAY DOOR S.L.
SCALE 1/2" = 1'-0"

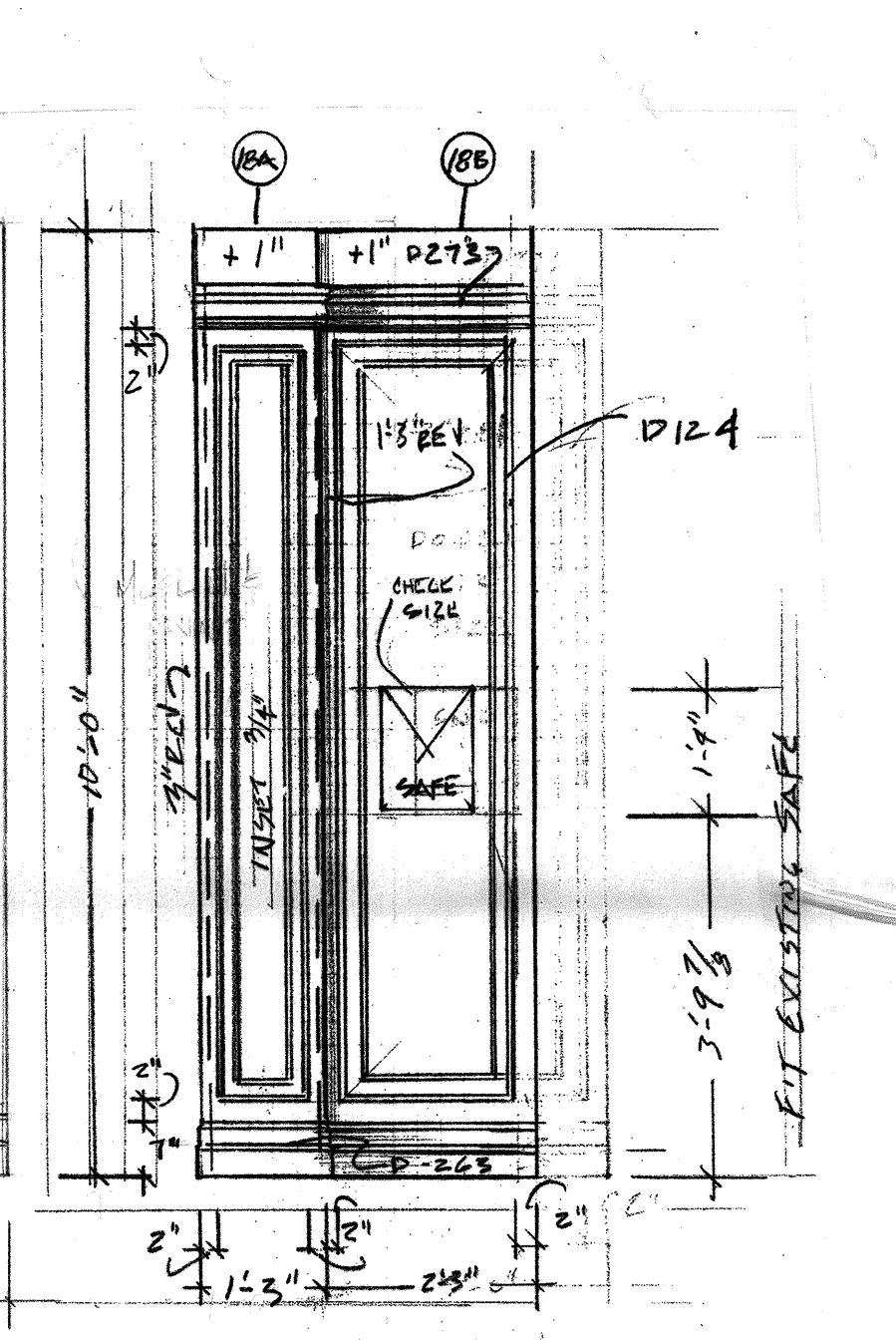
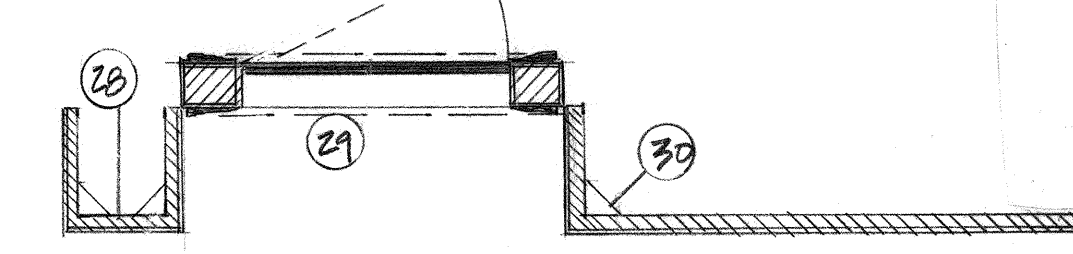

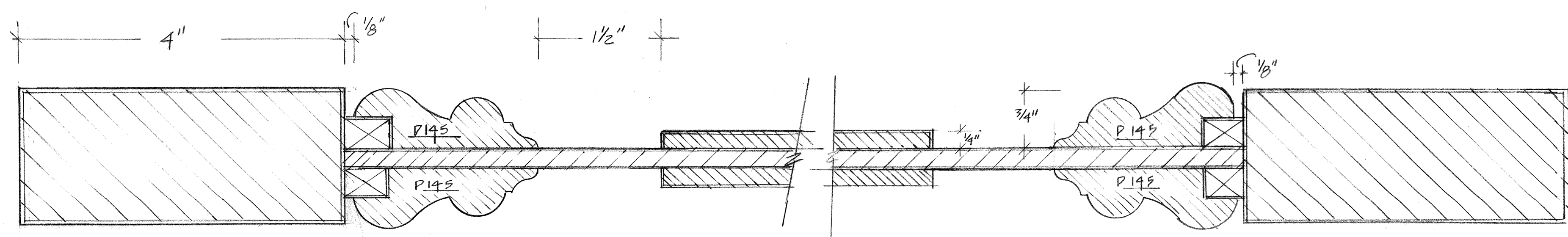

I SAFE PLATFORM
SCALE 1/2" = 1'-0"



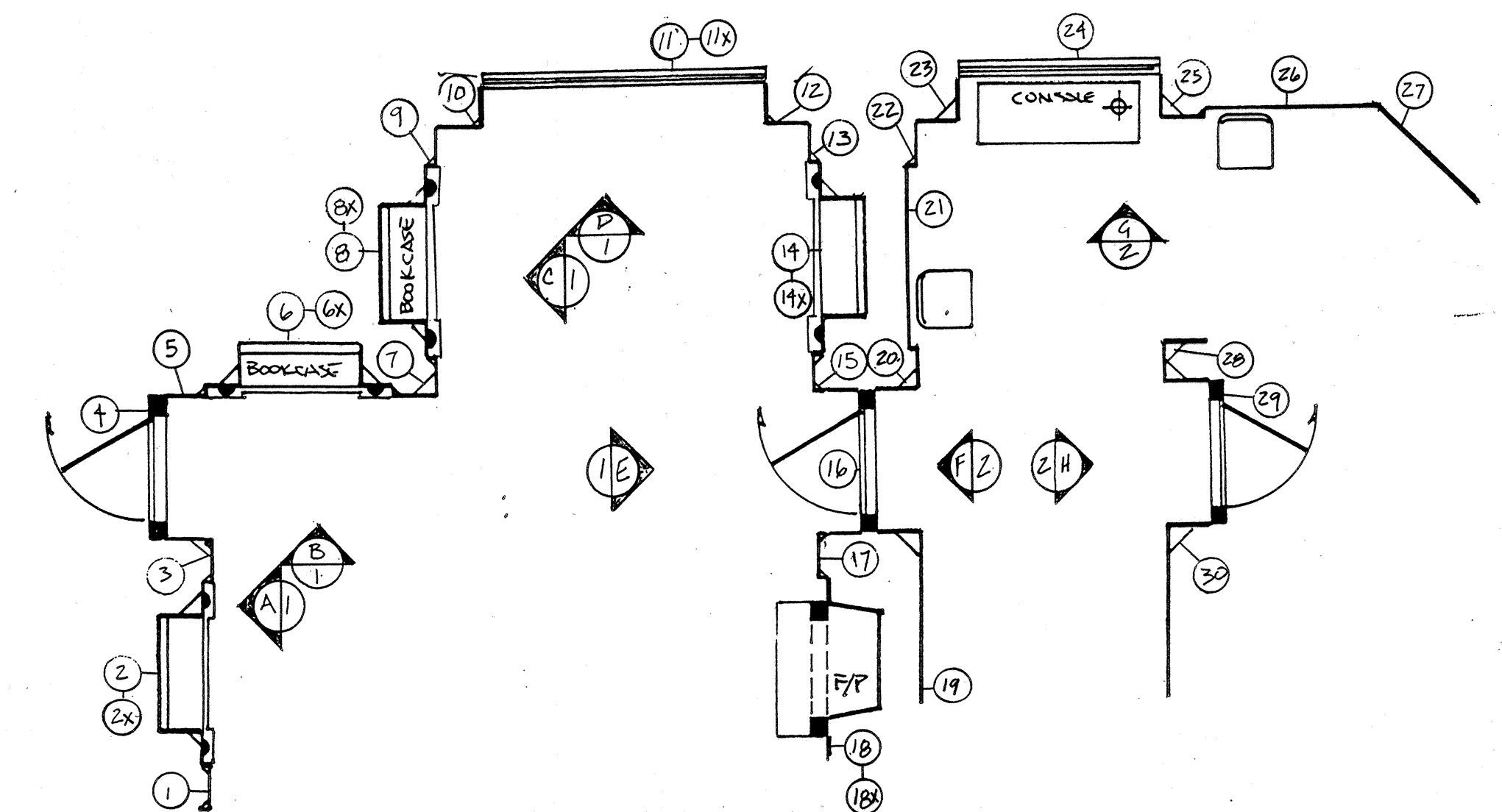

P2 DOOR DETAIL
FULL SCALE

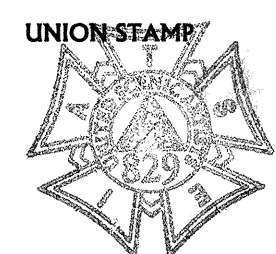

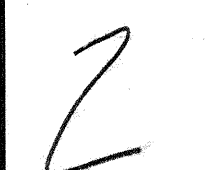
CHANDLER LIBRARY
SCALE 1/4" = 1'-0"

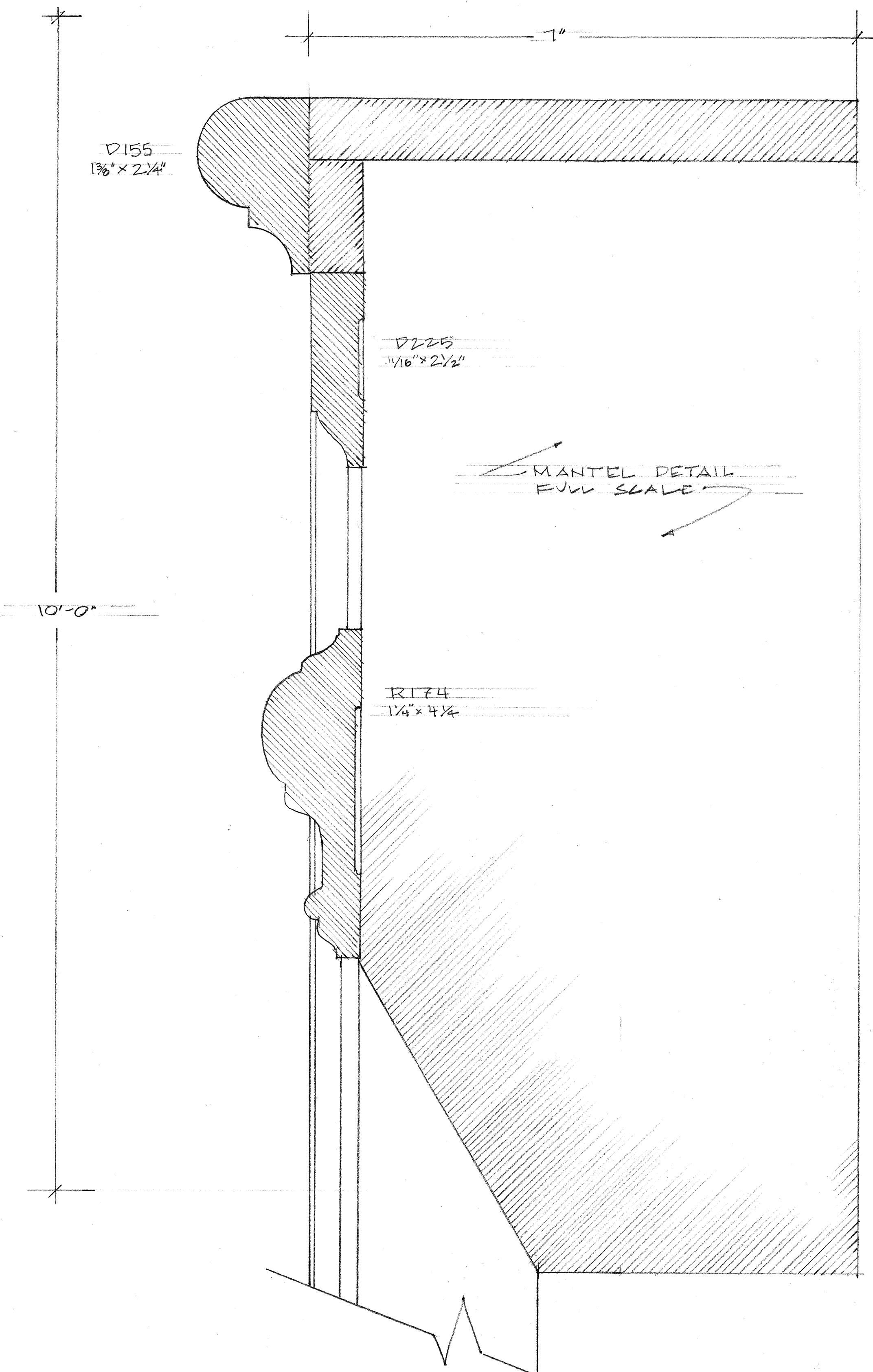
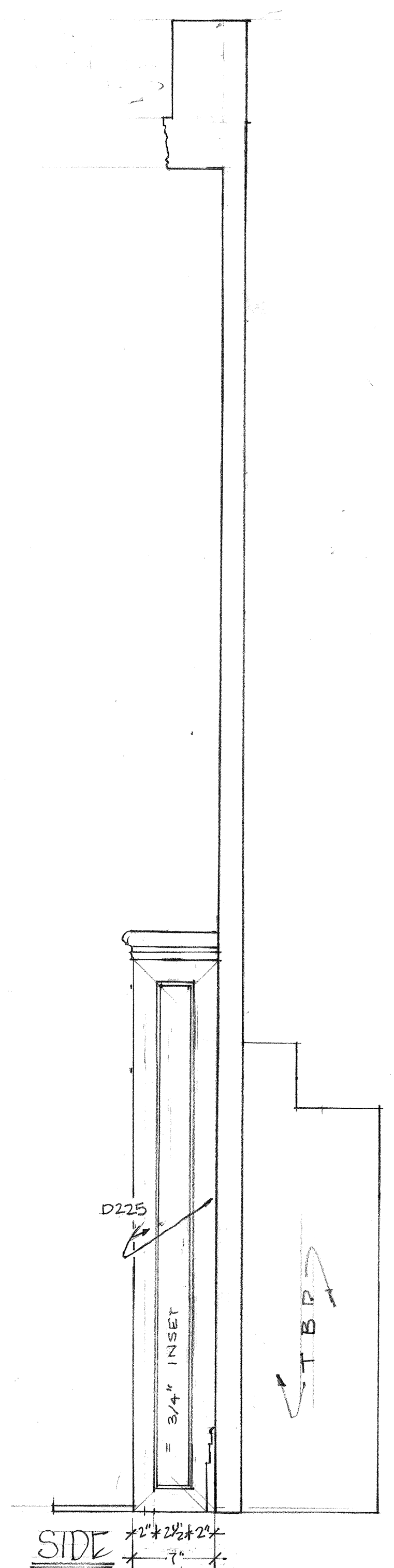
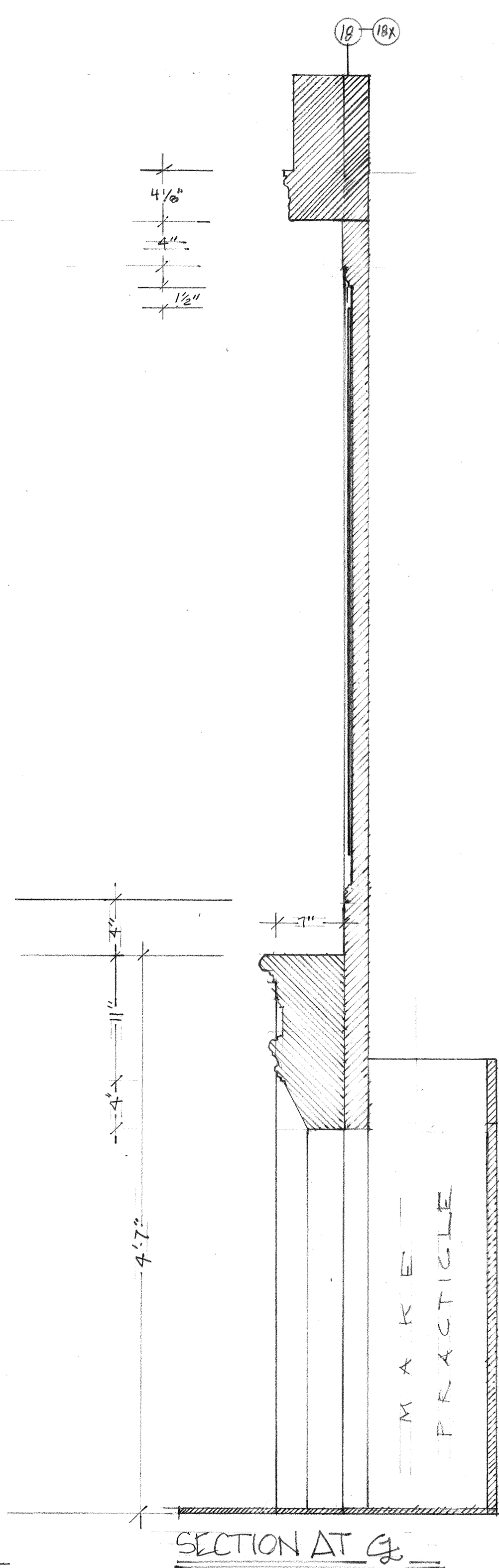
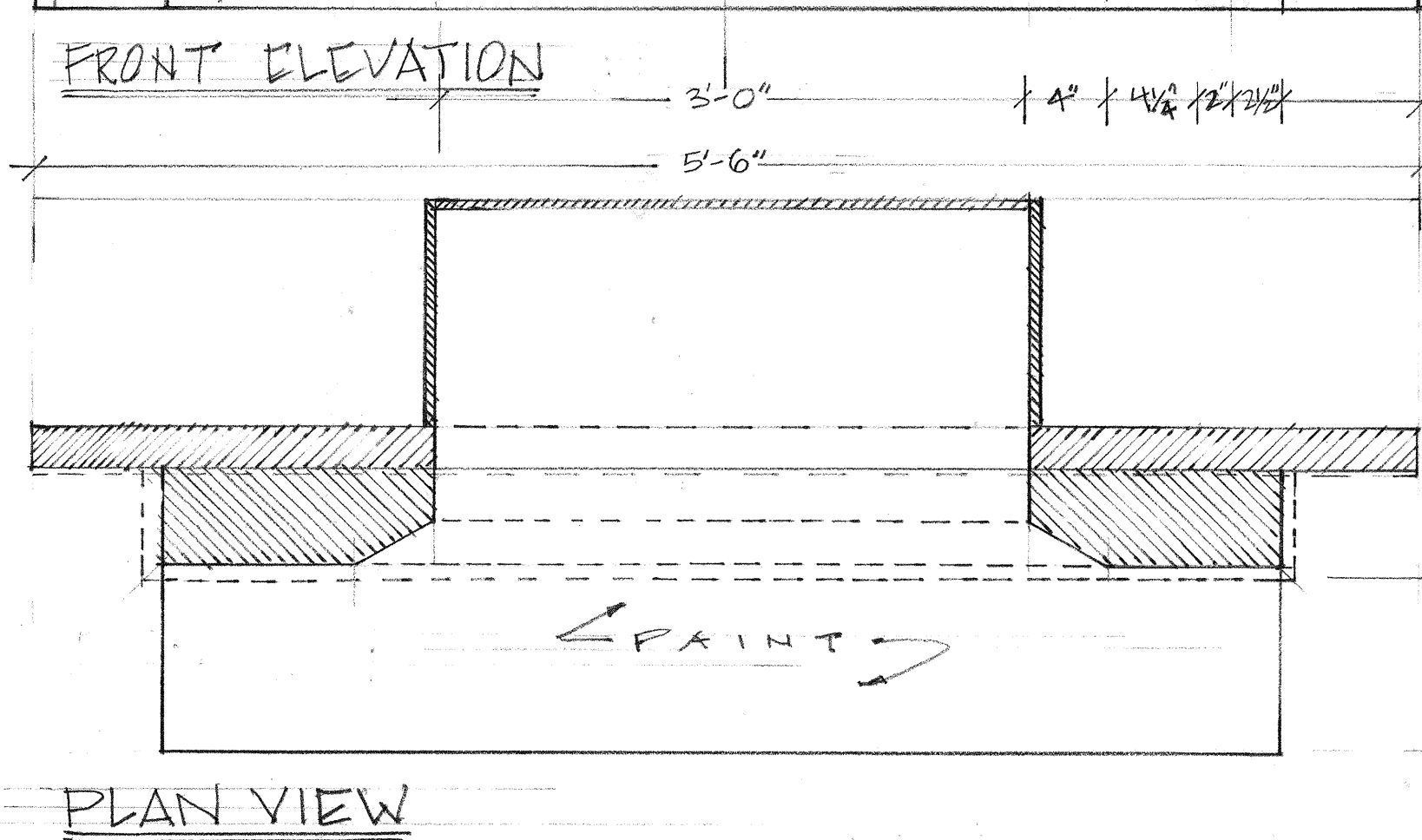
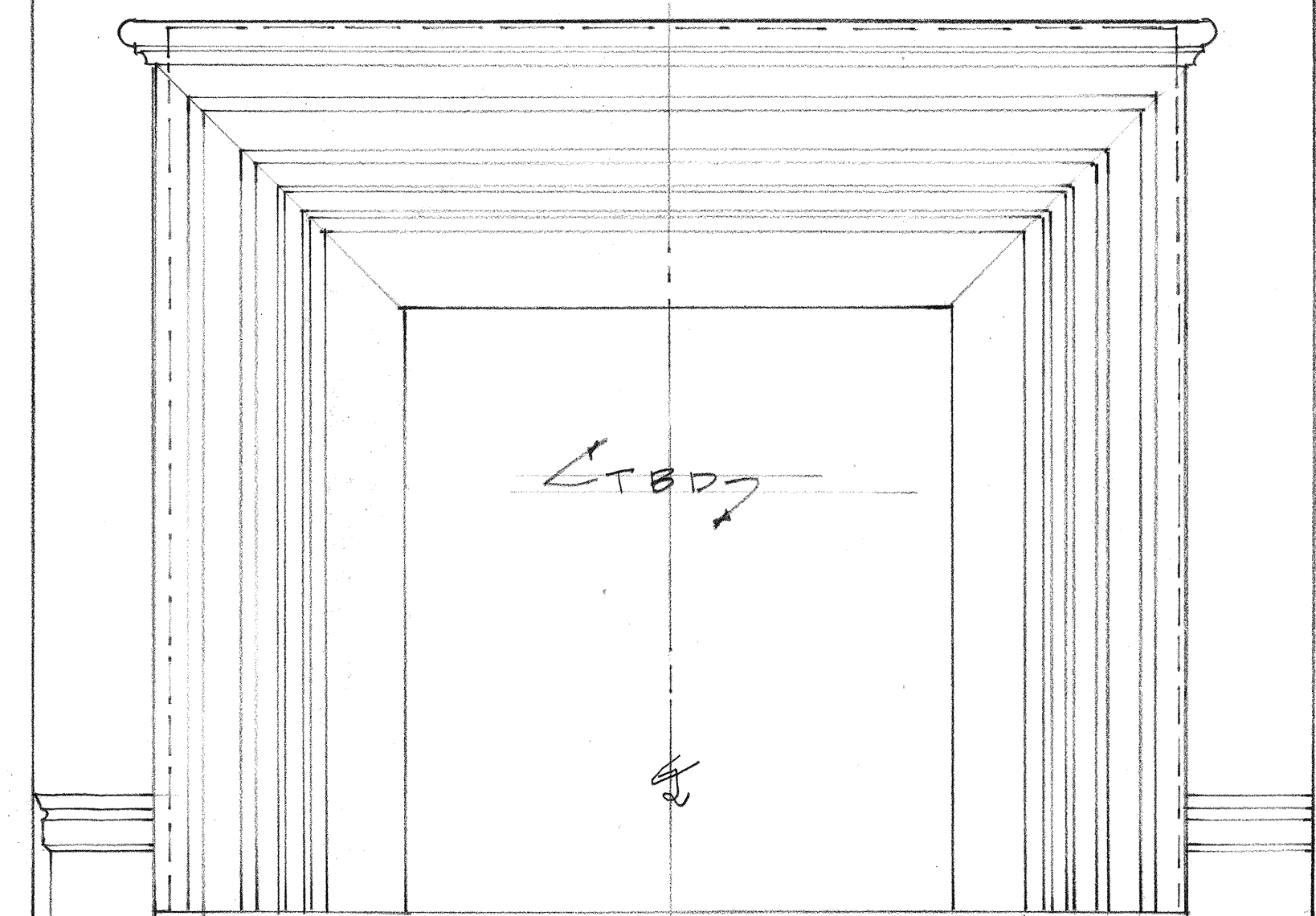
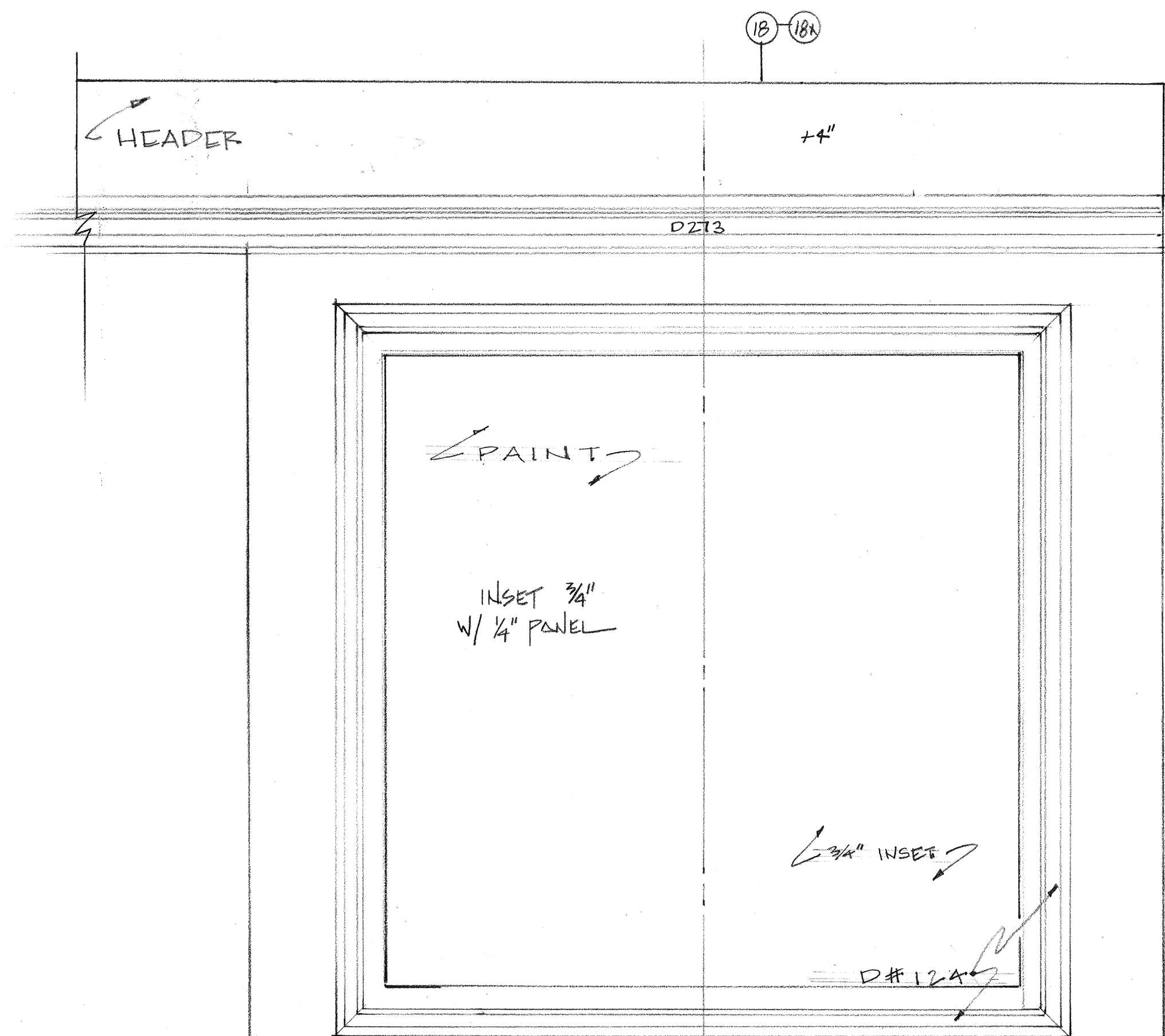
 S.D. 1104 SCENIC DESIGNER SIGNATURE: <i>ADL</i>	AMERICAN BROADCASTING COMPANIES 		DRAWING NO.
	PROD: ALL MY CHILDREN	STUDIO TV 23	
	SET: CHANDLER LIBRARY		
	SCALE: NOTED DRAWN: 2-5-02 DATE:	DEL. DATE: 2-27-02 PROD. DATE: 2-28-02	OF 3
DESIGNER: P. MOONEY	DRAFTSMAN: H. HANKEP		

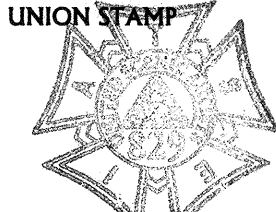

 S.D. 1104 SCENIC DESIGNER SIGNATURE: <i>102</i>	AMERICAN BROADCASTING COMPANIES 		DRAWING NO. <i>3</i>
	PROD.: "ALL MY CHILDREN"	STUDIO TV 23	 OF 3
	SET: <i>Stock Fireplace #4</i>	CHARLES LIBERTY	
	SCALE: 1 1/2"=1'-0" FULL	DEL. DATE: 2-27-2002	
	DRAWN: DATE 2-6-2002	PROD. DATE: 2-28-2002	
DESIGNER: <i>R. MOONEY</i>	DRAFTSMAN: <i>CHAS PLUMMER</i>		