

A-A SECTION A-A  
SCALE 1/2"=1'-0"

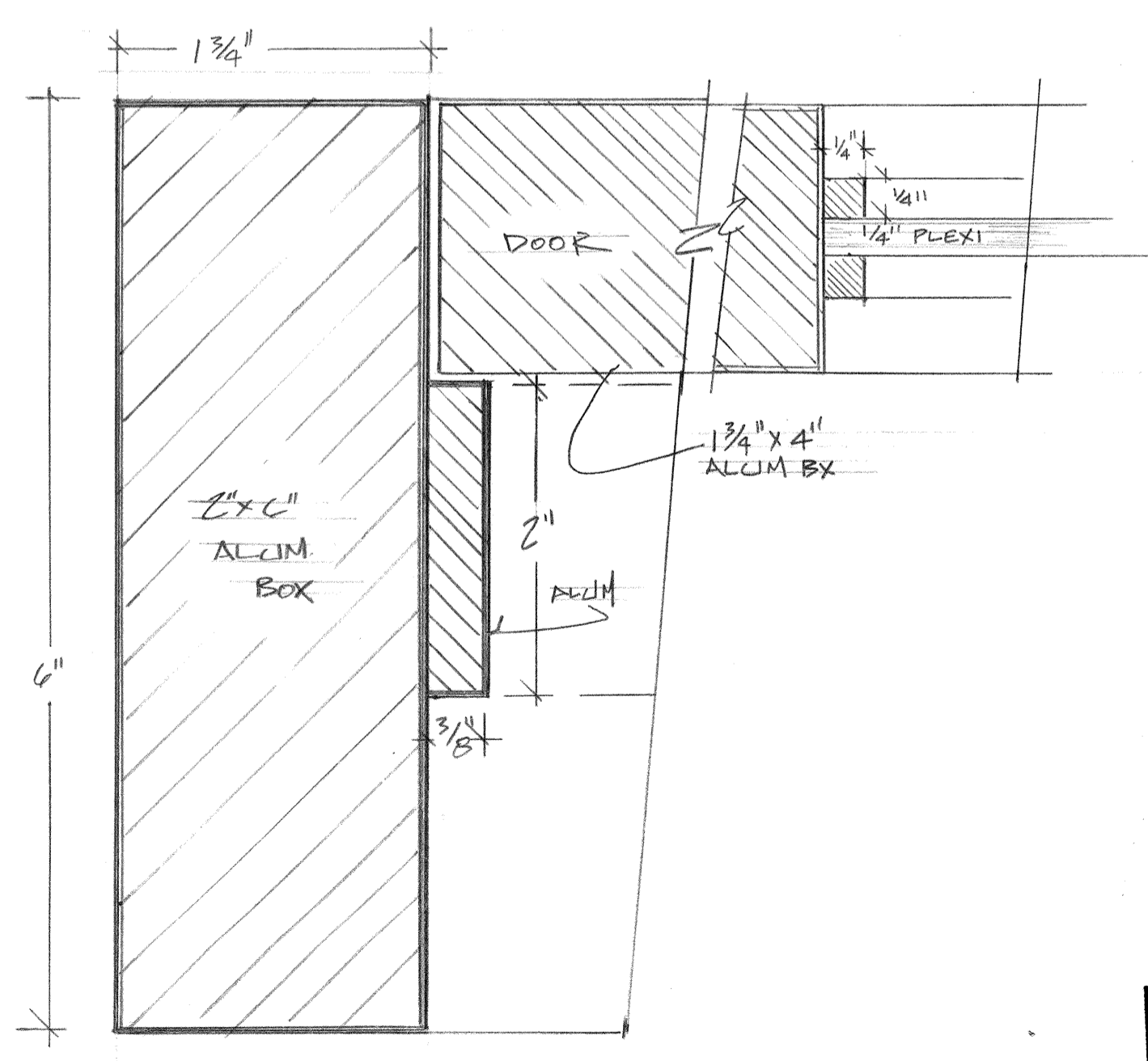

D1 DOOR DETAIL  
FULL SCALE

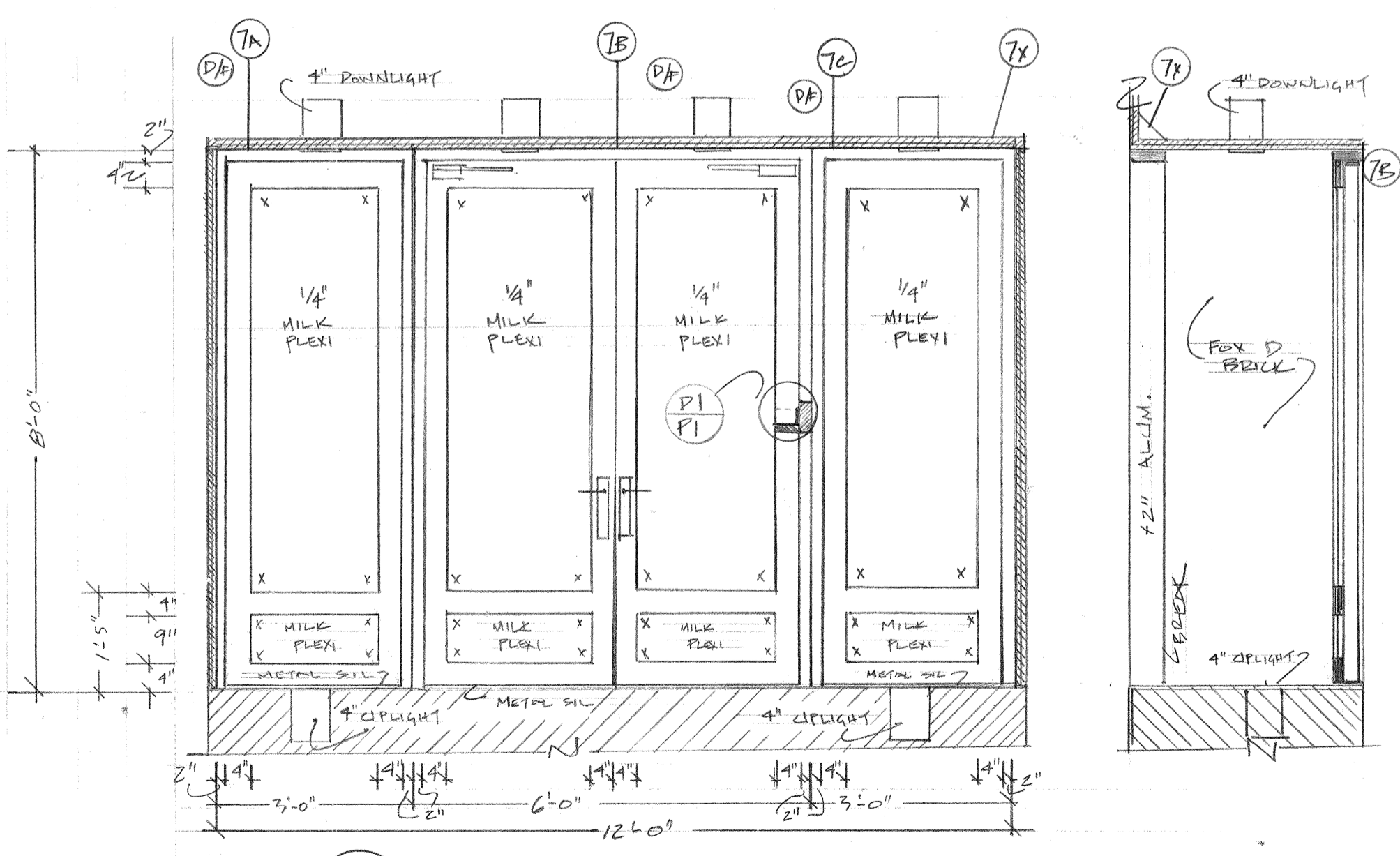
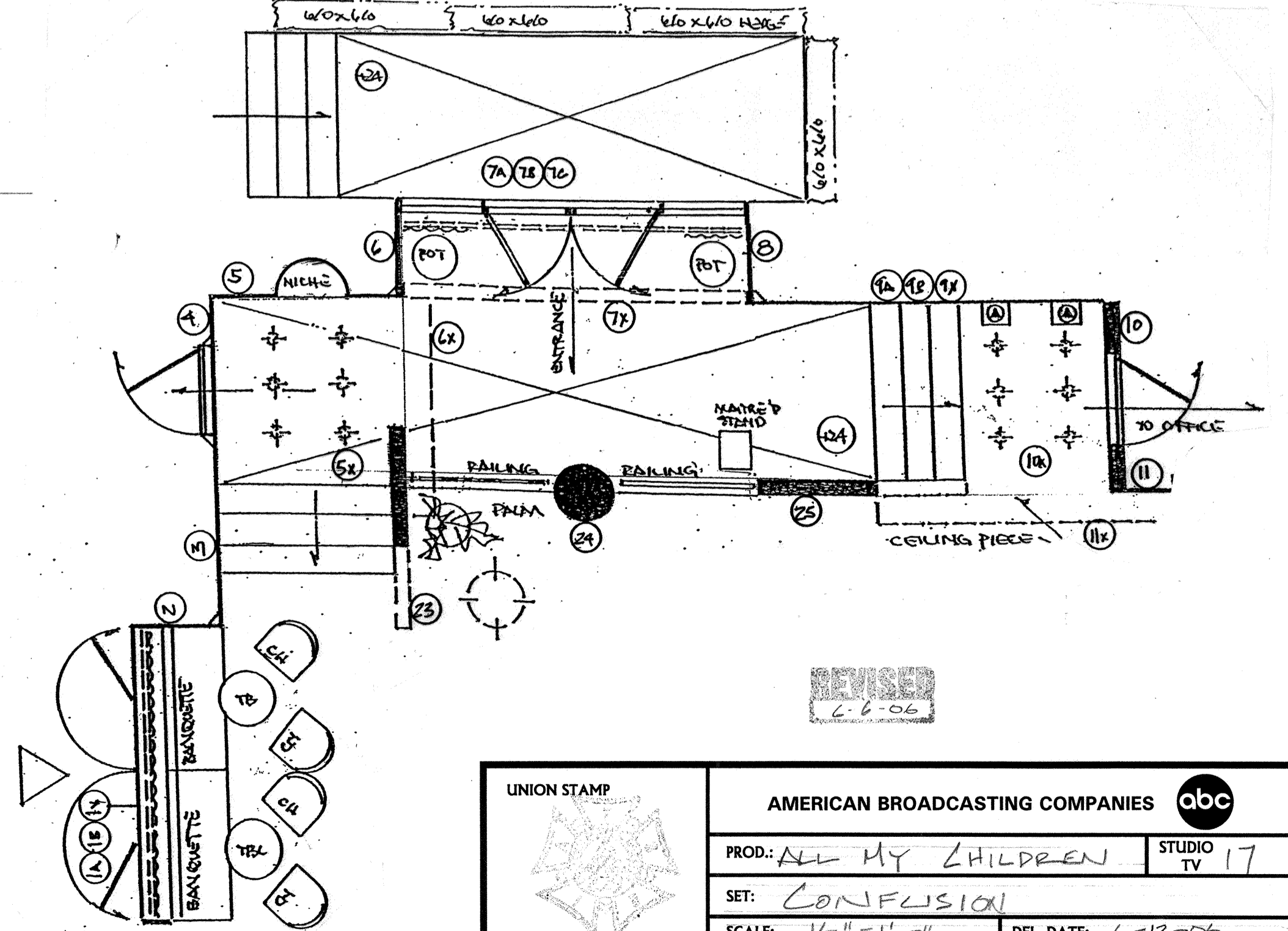

UNION STAMP  S.D. 1104 SCENIC DESIGNER	AMERICAN BROADCASTING COMPANIES <b>abc</b>		DRAWING NO. 1
	PROD: ALL MY CHILDREN		STUDIO TV 17
	SET: CONFUSION		
	SCALE: 1/2"=1'-0"	DEL. DATE: 6-12-06	
	DRAWN: 6-26-06	PROD. DATE: 6-13-06	
DESIGNER: R. MOONEY		DRAFTSMAN: M. FAHRER	



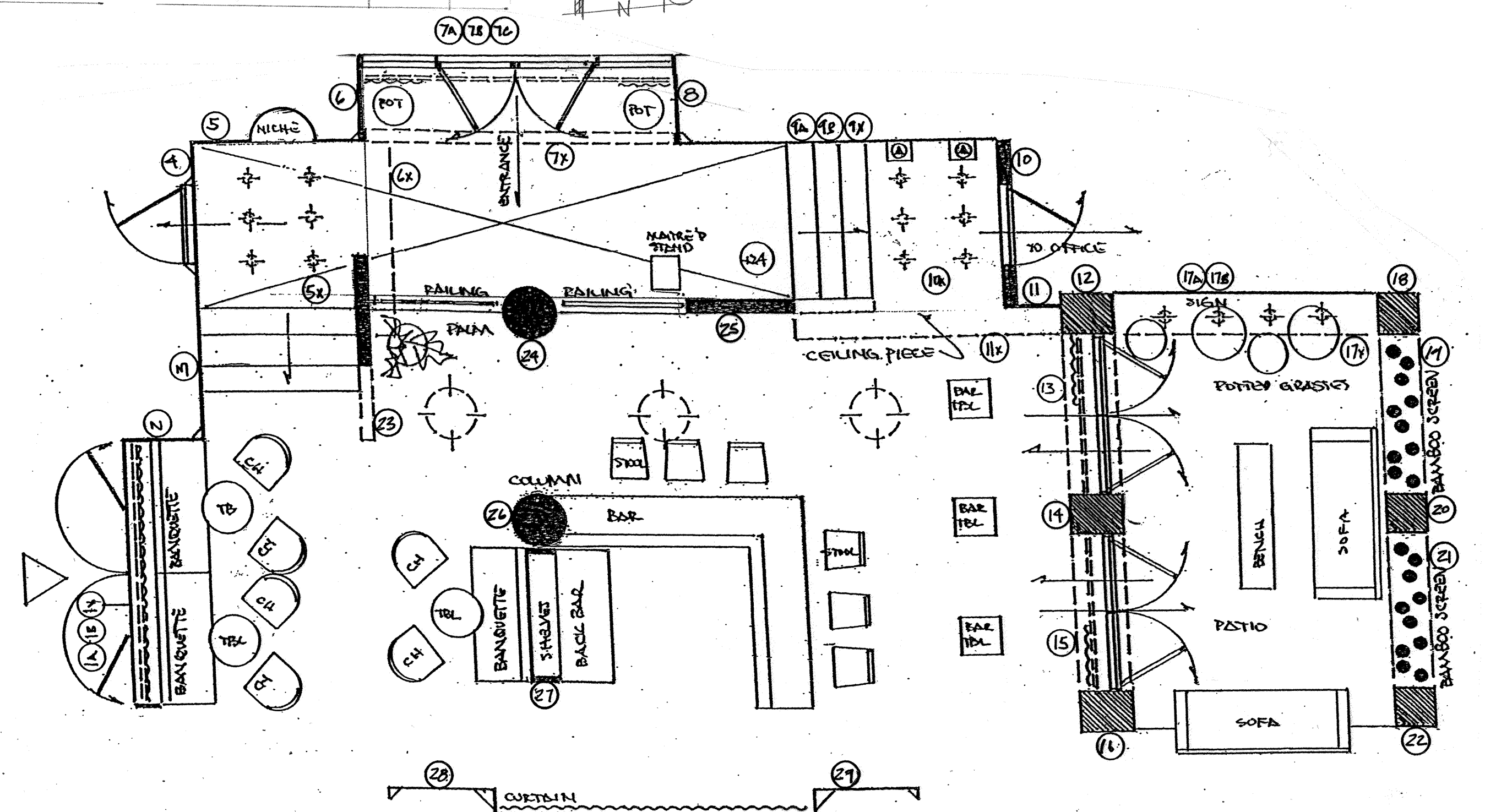
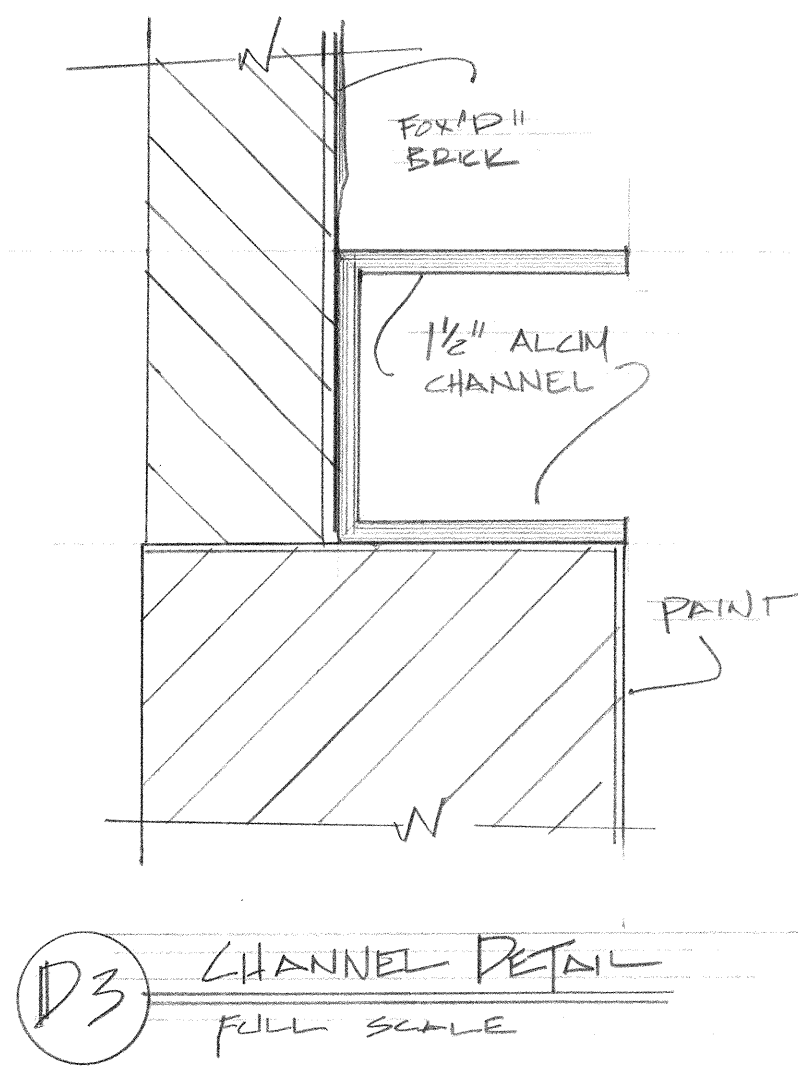
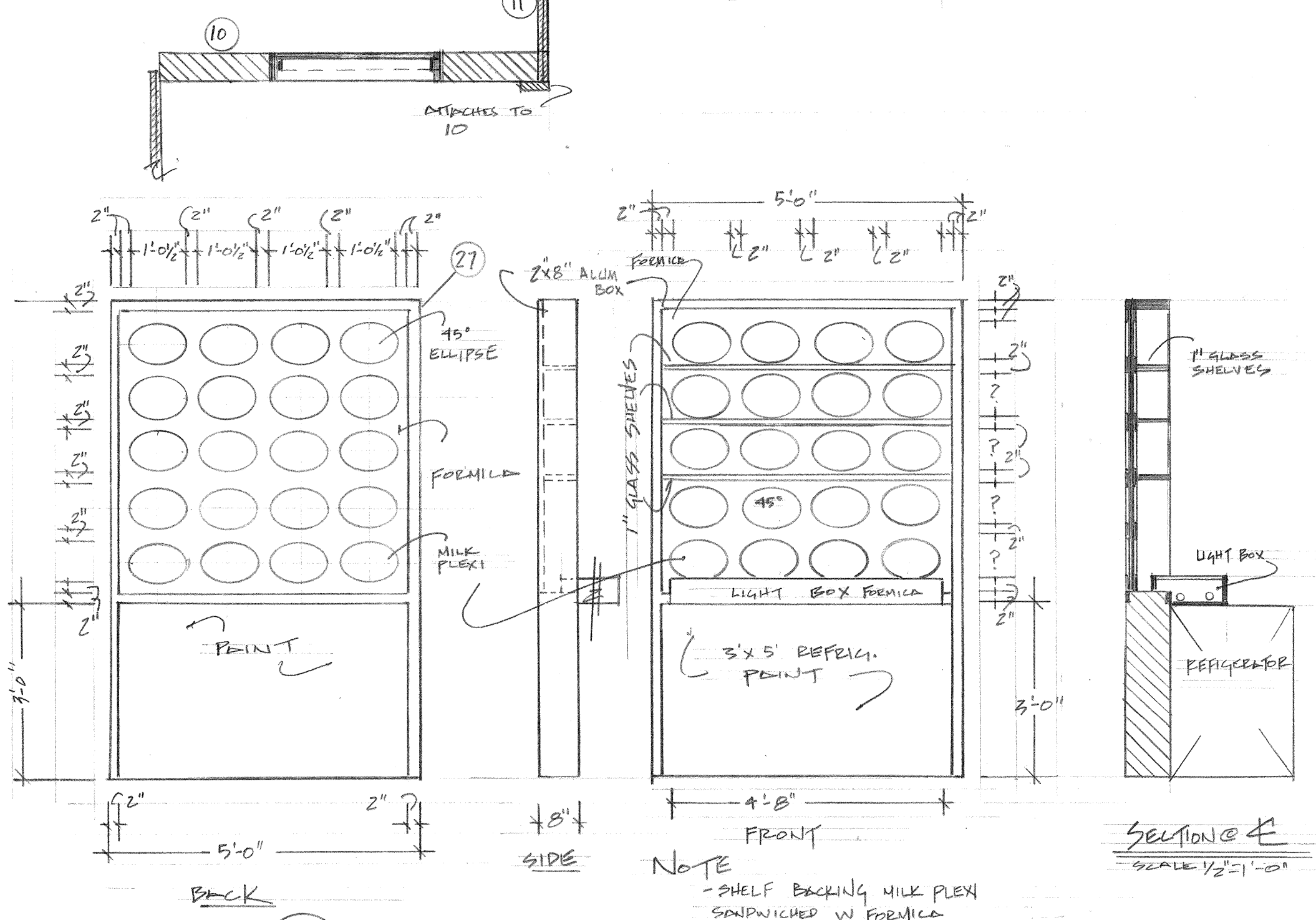
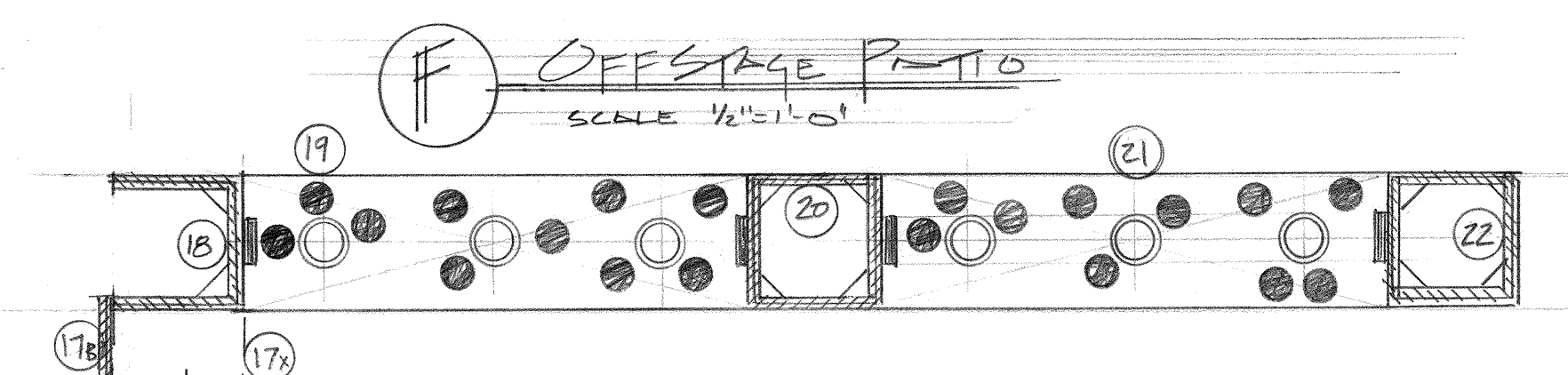
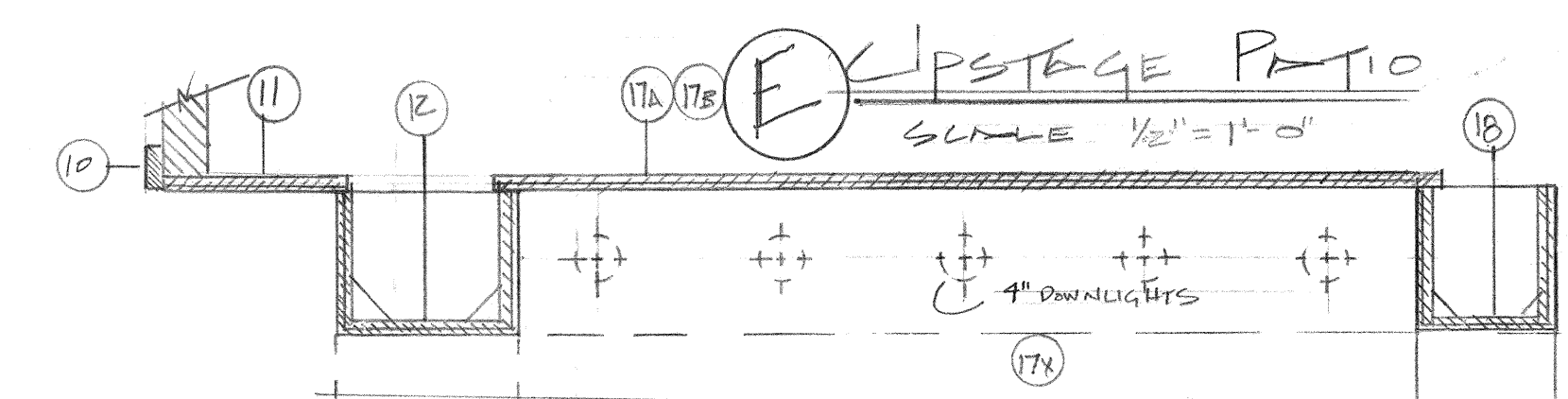
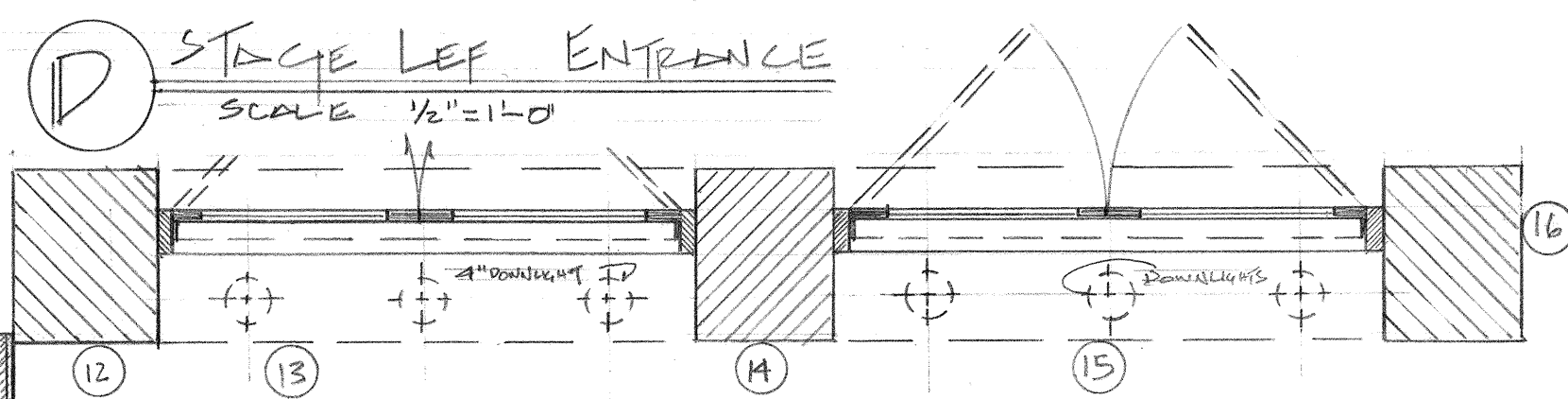
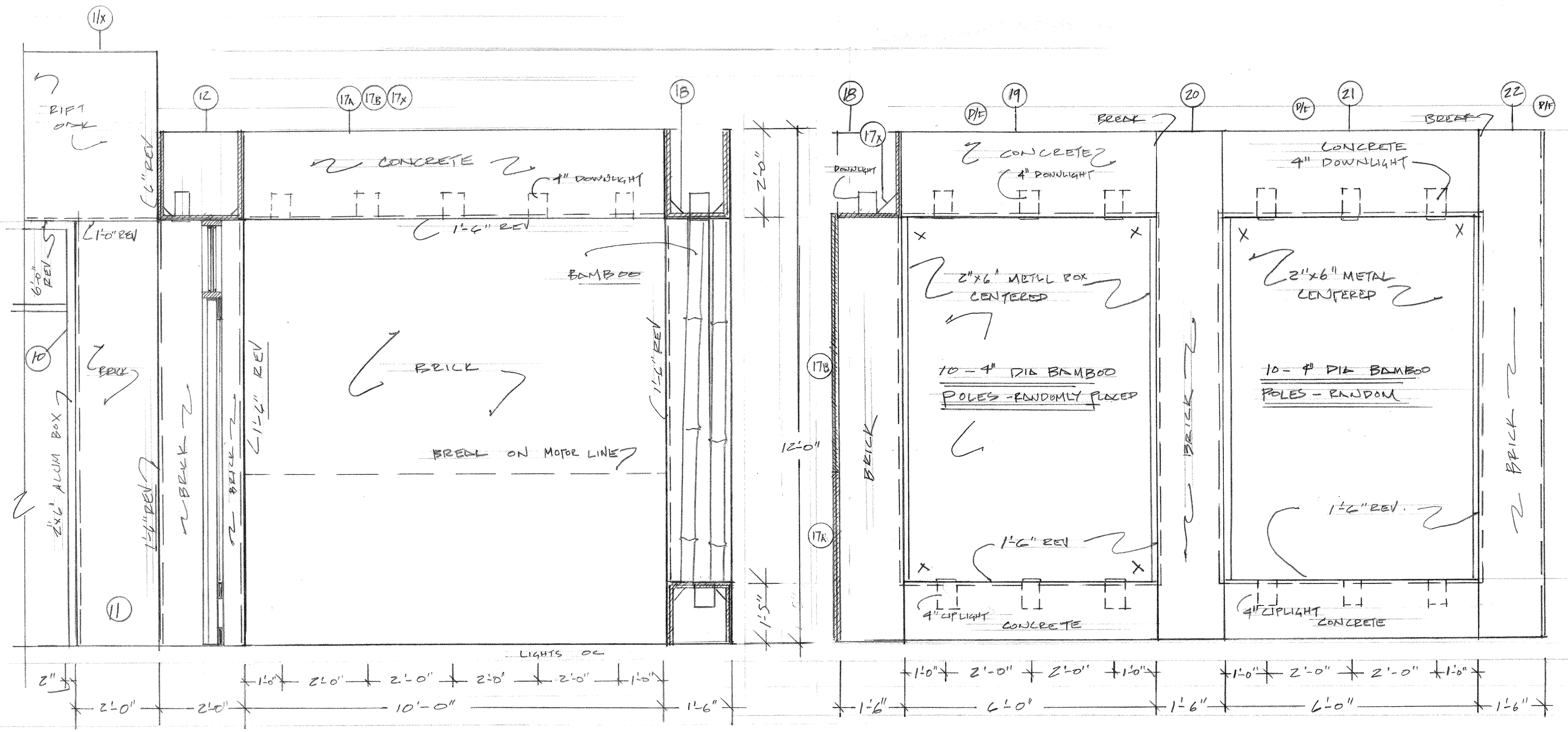
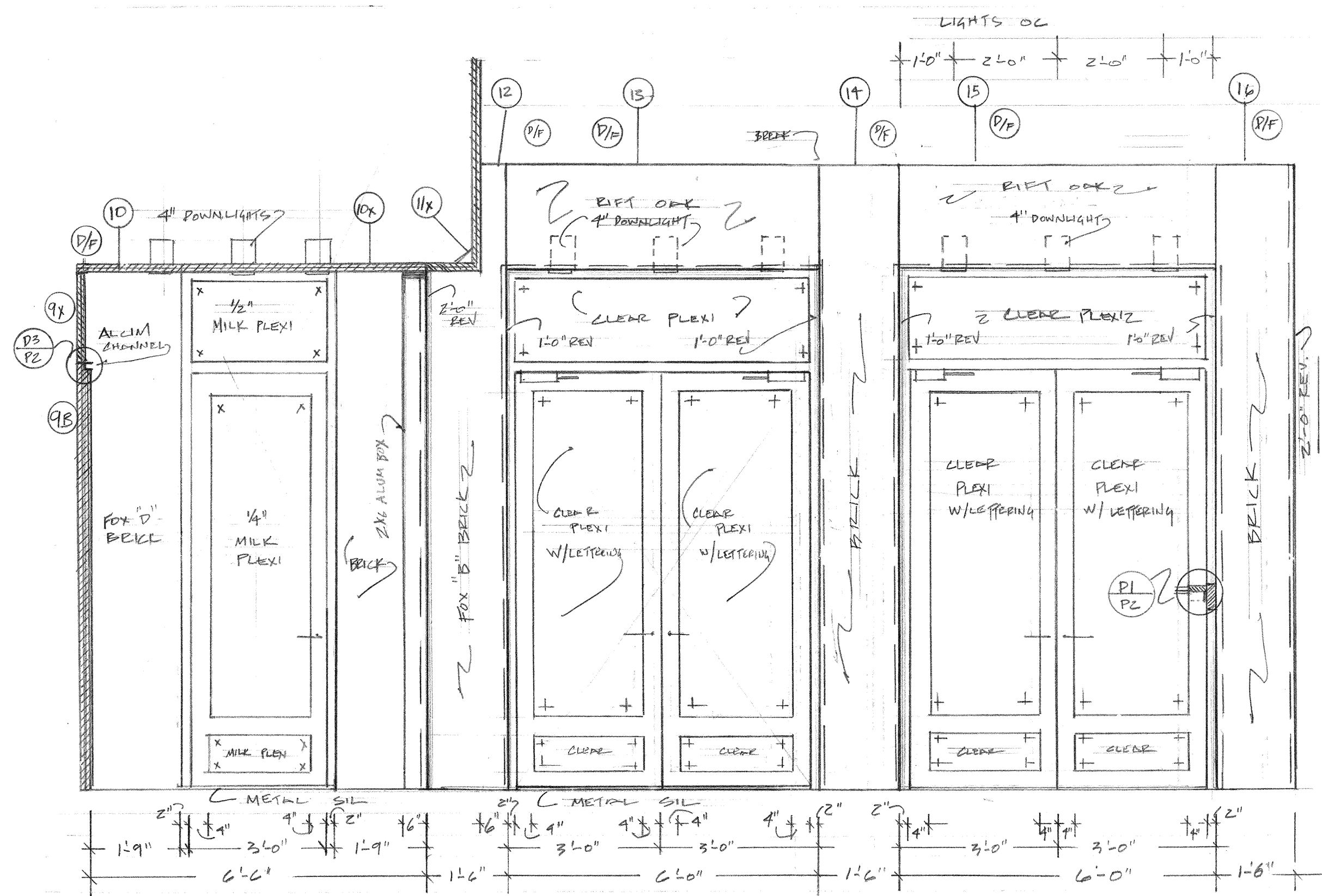

UNION STAMP  S.D. 1104 SCENIC DESIGNER J.P.	<b>AMERICAN BROADCASTING COMPANIES</b> abc		DRAWING NO. 2	
	PROD.: ALL MY CHILDREN		STUDIO 23 TV	
	SET: CONFUSION			OF 4
	SCALE: 1/2" = 1'-0"	DEL. DATE: 6-9-06		
	DRAWN:	PROD. DATE: 6-12-06		
DESIGNER: J.P. MURPHY		DRAFTSMAN: N. FAHREN		



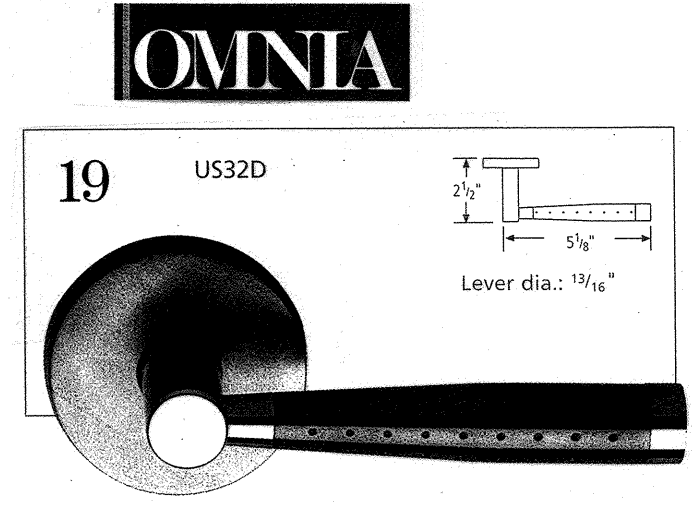
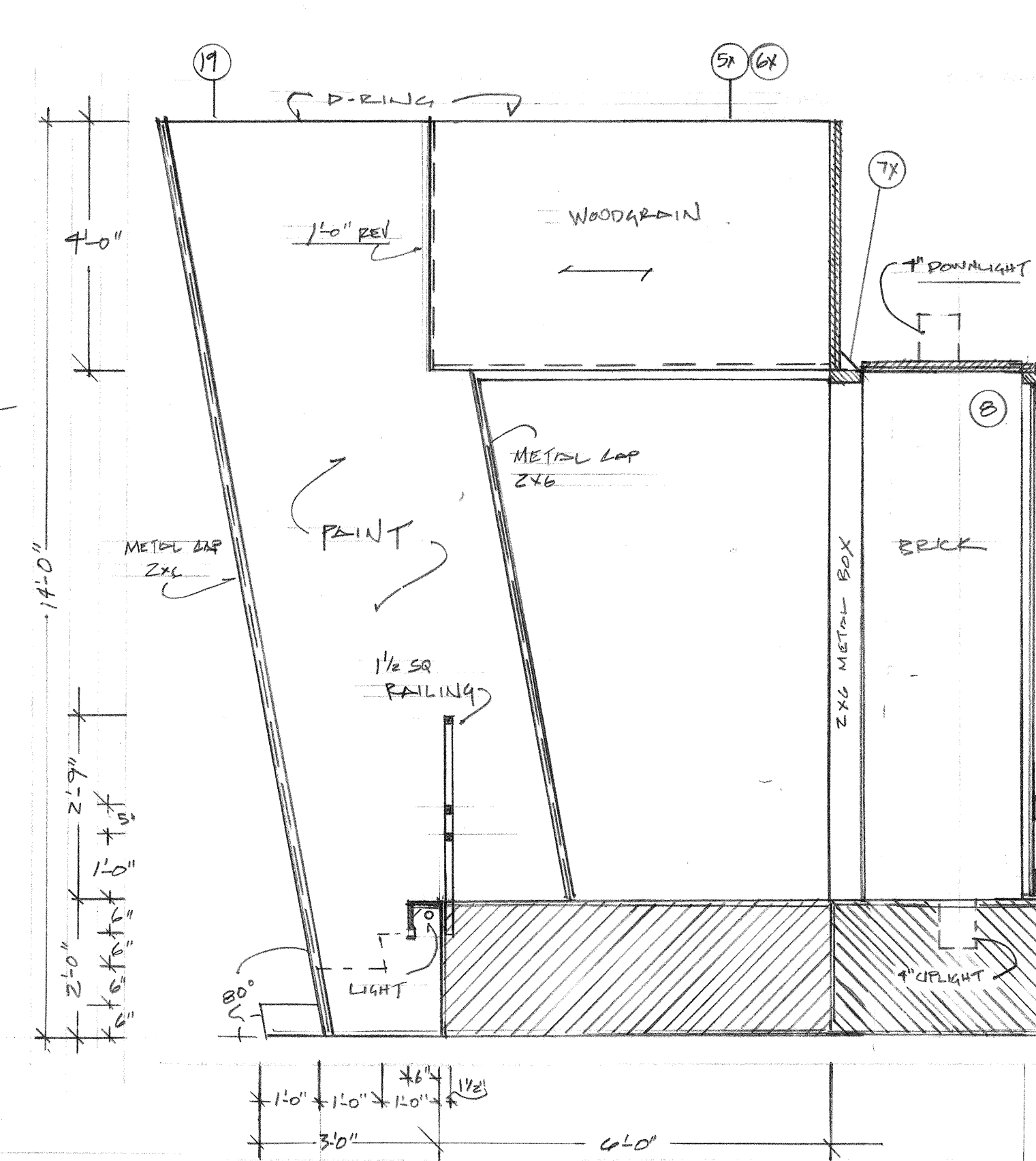
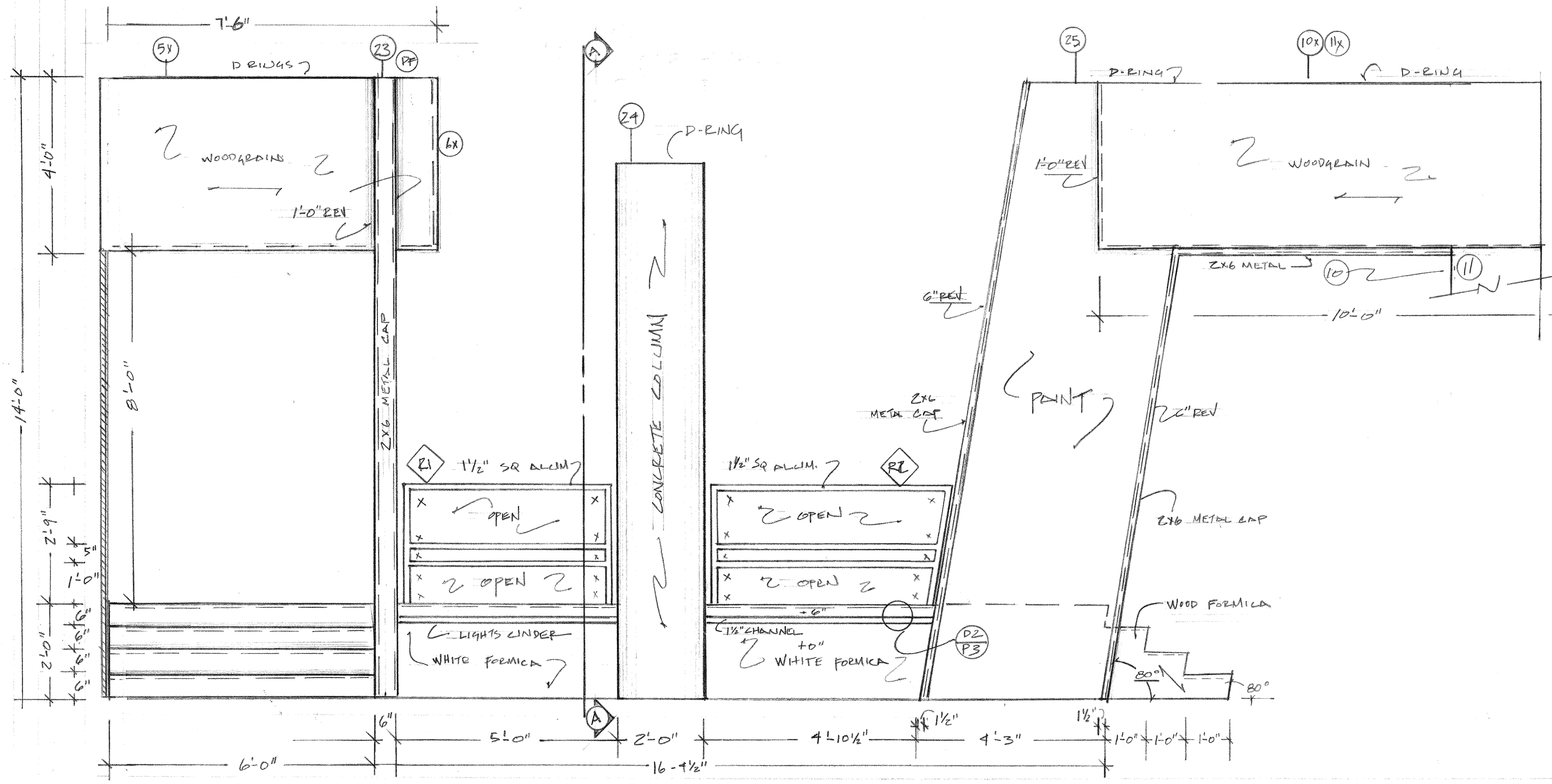

**H PLATFORM & FACING**  
SCALE 1/2"=1'-0"

**A.A. SECTION A-A**  
SCALE 1/2"=1'-0"

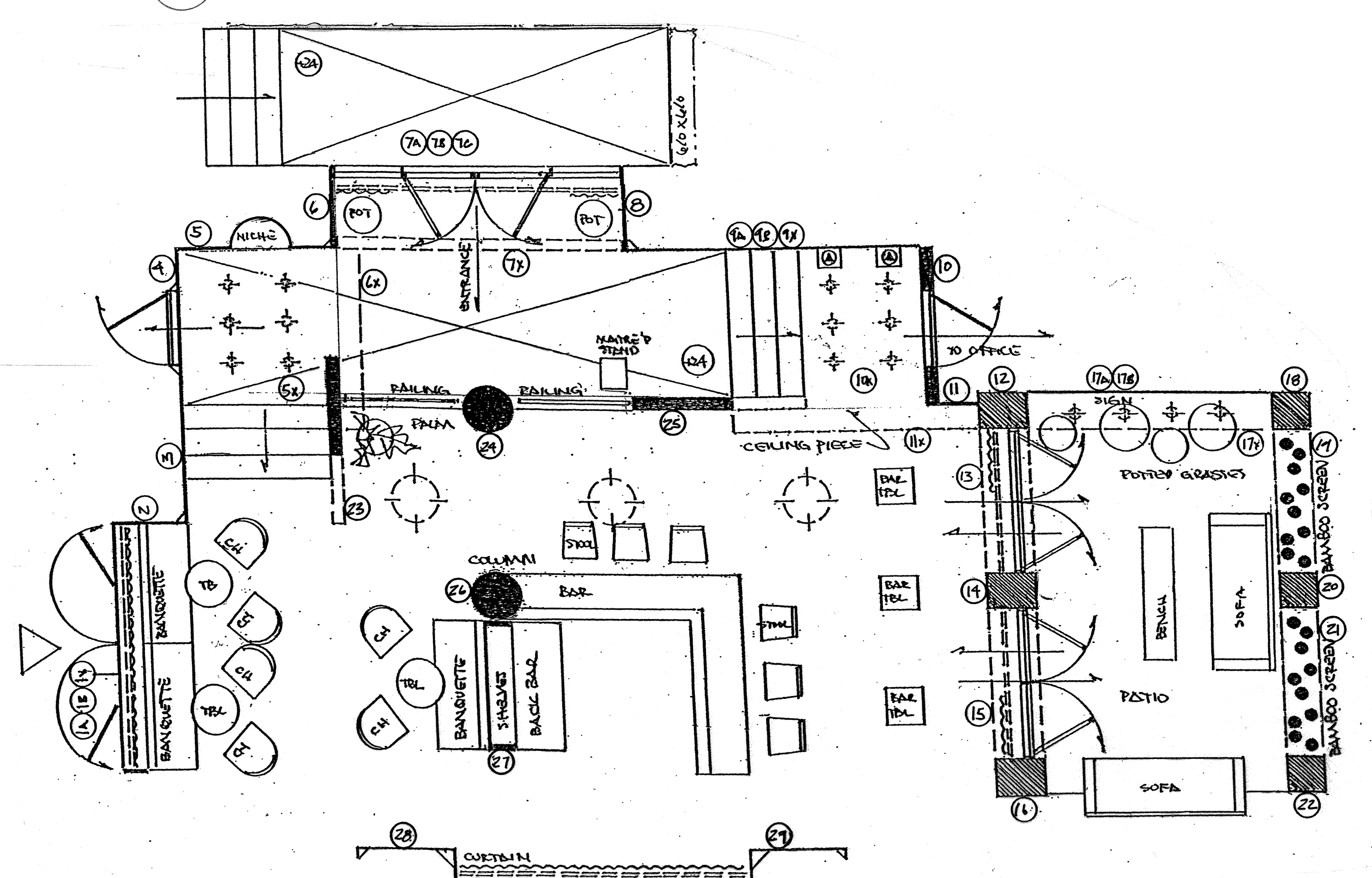
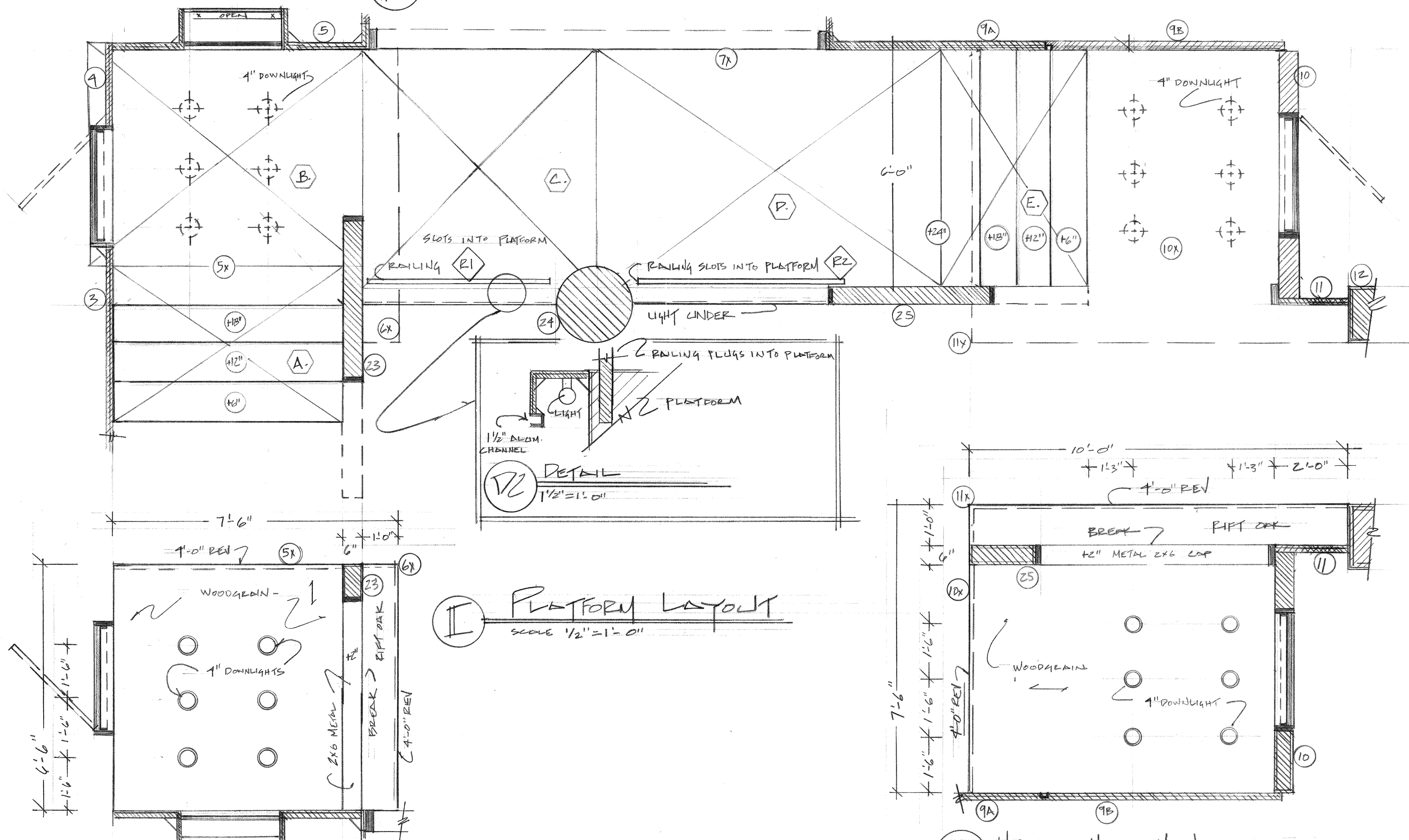

**J HEADER MIRROR VIEW**  
SCALE 1/2"=1'-0"

**K HEADER MIRROR VIEW**  
SCALE 1/2"=1'-0"

	<b>AMERICAN BROADCASTING COMPANIES</b> abc		DRAWING NO.
	PROD.: <b>ALL MY CHILDREN</b>	STUDIO TV <b>23</b>	<b>3</b>
SET: <b>CONFUSION</b>	SCALE: NOTED	DEL. DATE: 6-12-06	
DRAWN: <b>5-30-06</b>	DATE:	PROD. DATE: 6-13-06	OF 4
DESIGNER: <b>R. MOONEY</b>	DRAFTSMAN: <b>M. FARRER</b>		



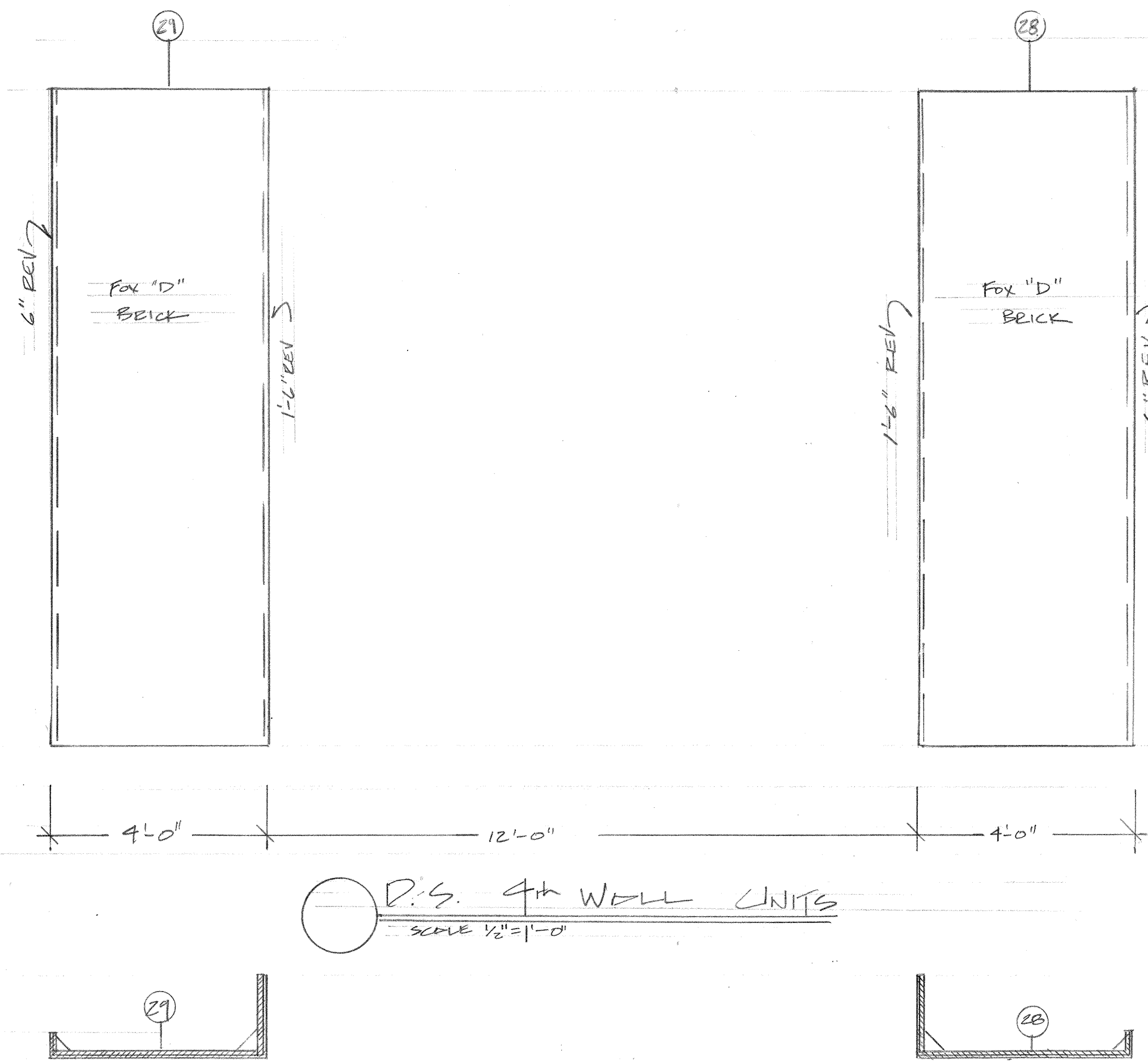

D.S. 4th WELL UNITS  
SCALE 1/2"=1'-0"

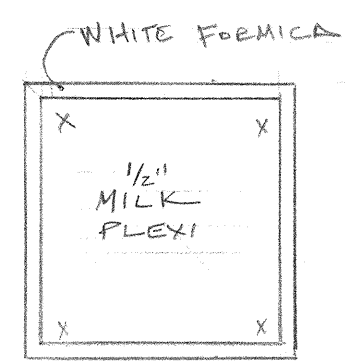

TOP

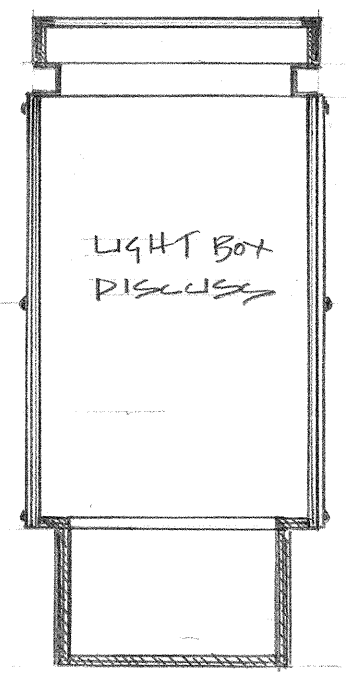
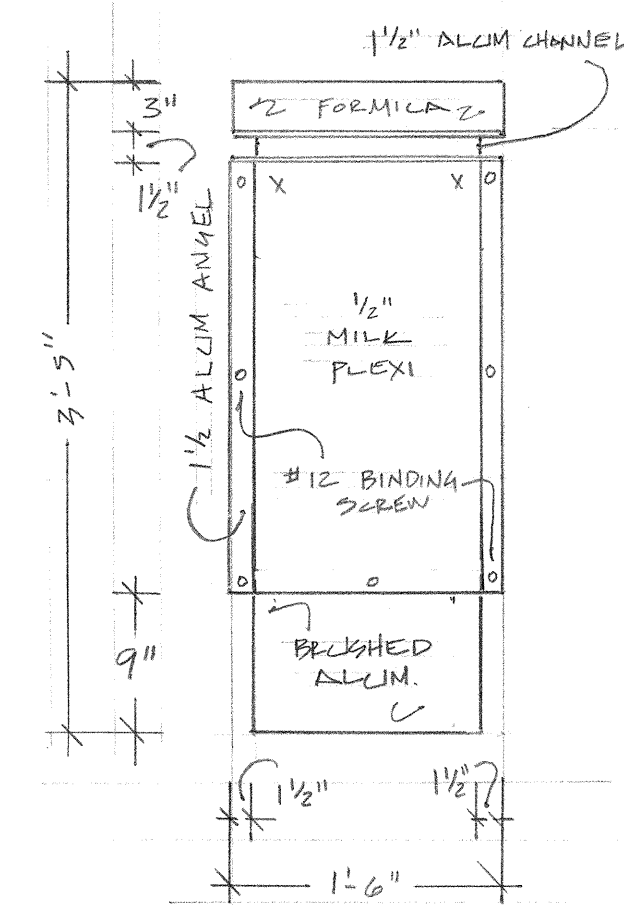

SECTION @ K

BAR TABLE MAKE 3  
SCALE 1/2"=1'-0"

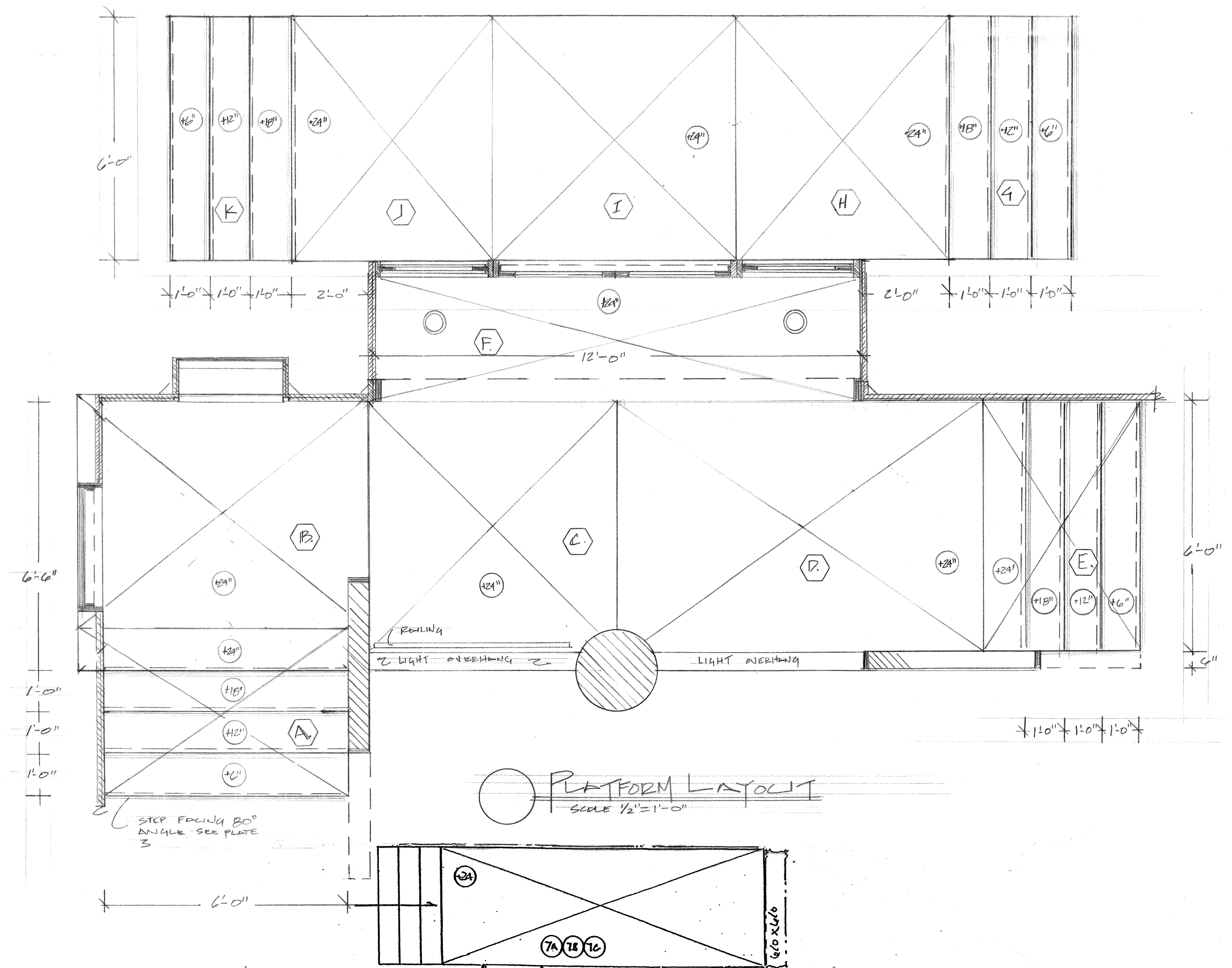
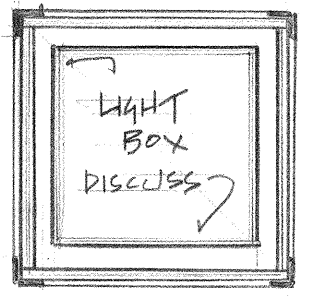

PLATFORM LAYOUT  
SCALE 1/2"=1'-0"

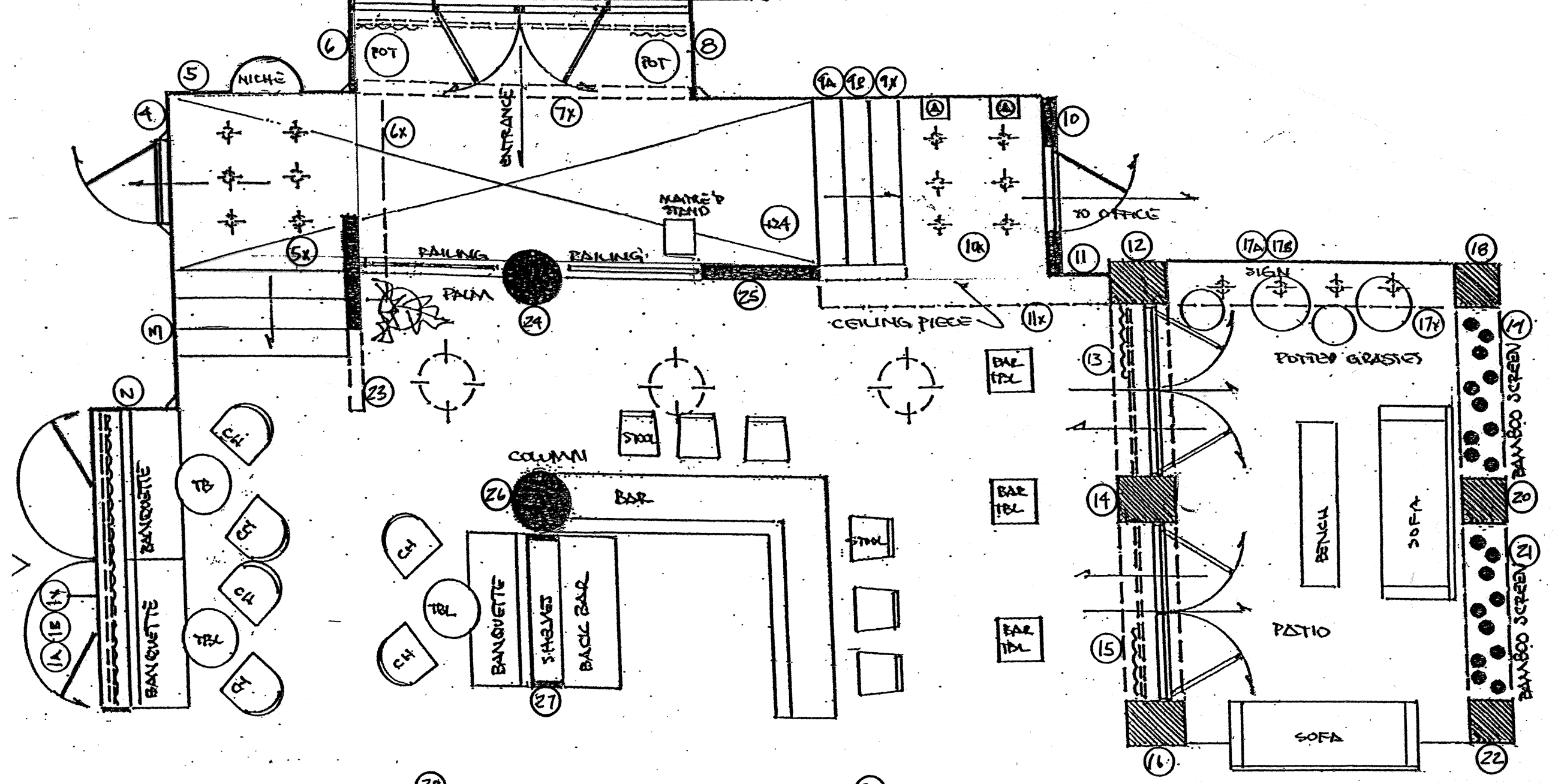

UNION STAMP  S.D. 1104 SCENIC DESIGNER	AMERICAN BROADCASTING COMPANIES <b>abc</b>		DRAWING NO. 4
	PROD.: ALL MY CHILDREN		STUDIO TV 23
	SET: CONFUSION		
	SCALE: 1/2"=1'-0"	DEL. DATE: 6-12-06	
	DRAWN: 5-31-06	PROD. DATE: 6-13-06	
DESIGNER: R. HOONLEY		DRAFTSMAN: M. FAHRER	



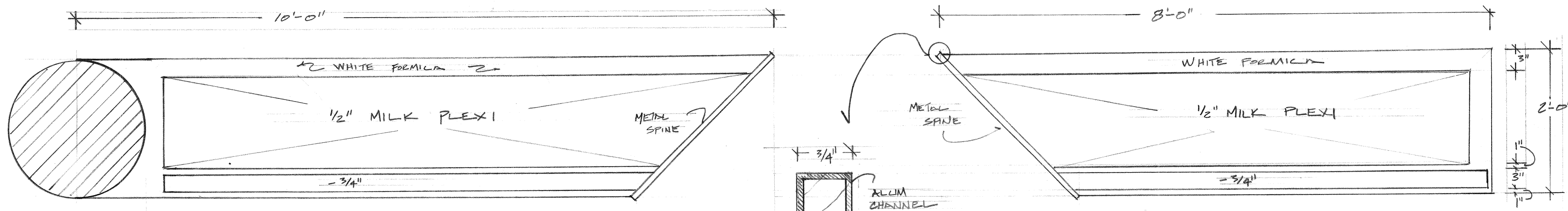

**A BAR TOP U.S.**  
SCALE 1"=1'-0"

**B BAR TOP SL**  
SCALE 1"=1'-0"

**D1 METAL SPINE**  
FULL SCALE

NOTES -  
- ALL FLUORESCENT LIGHTS DIMMABLE

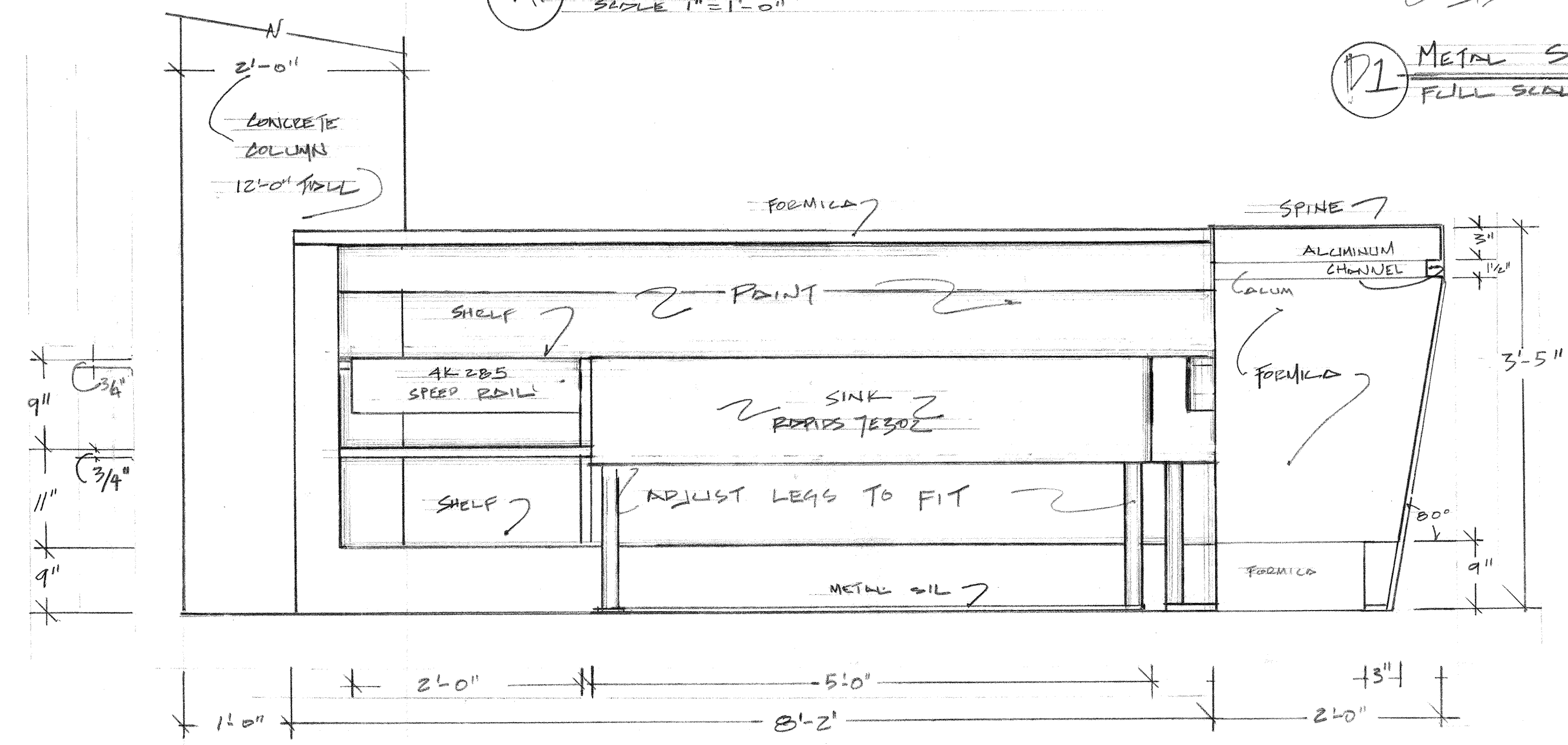

**C U.S. BAR P/F**  
SCALE 1"=1'-0"

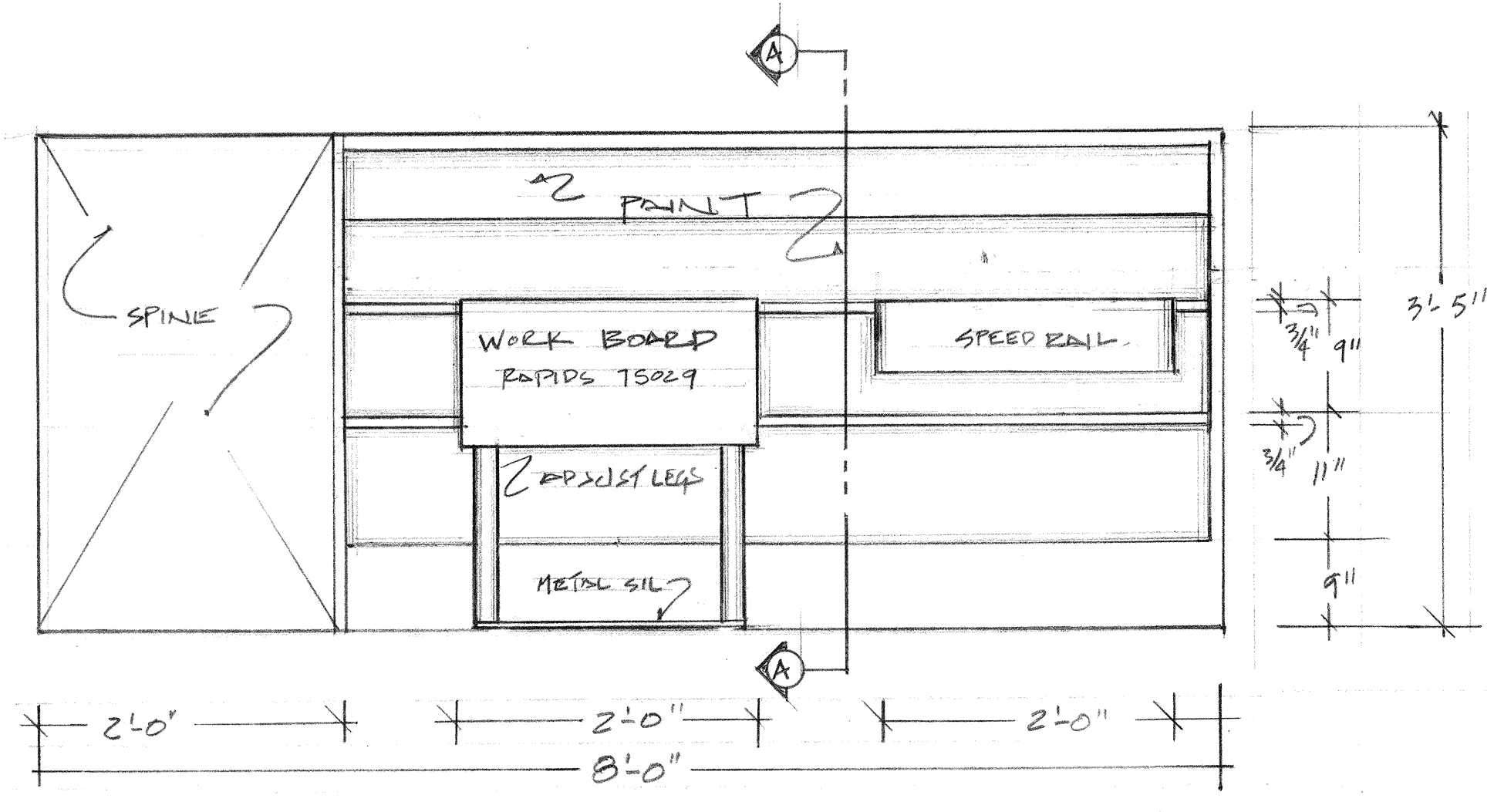

**D SL BAR INSIDE**  
SCALE 1"=1'-0"

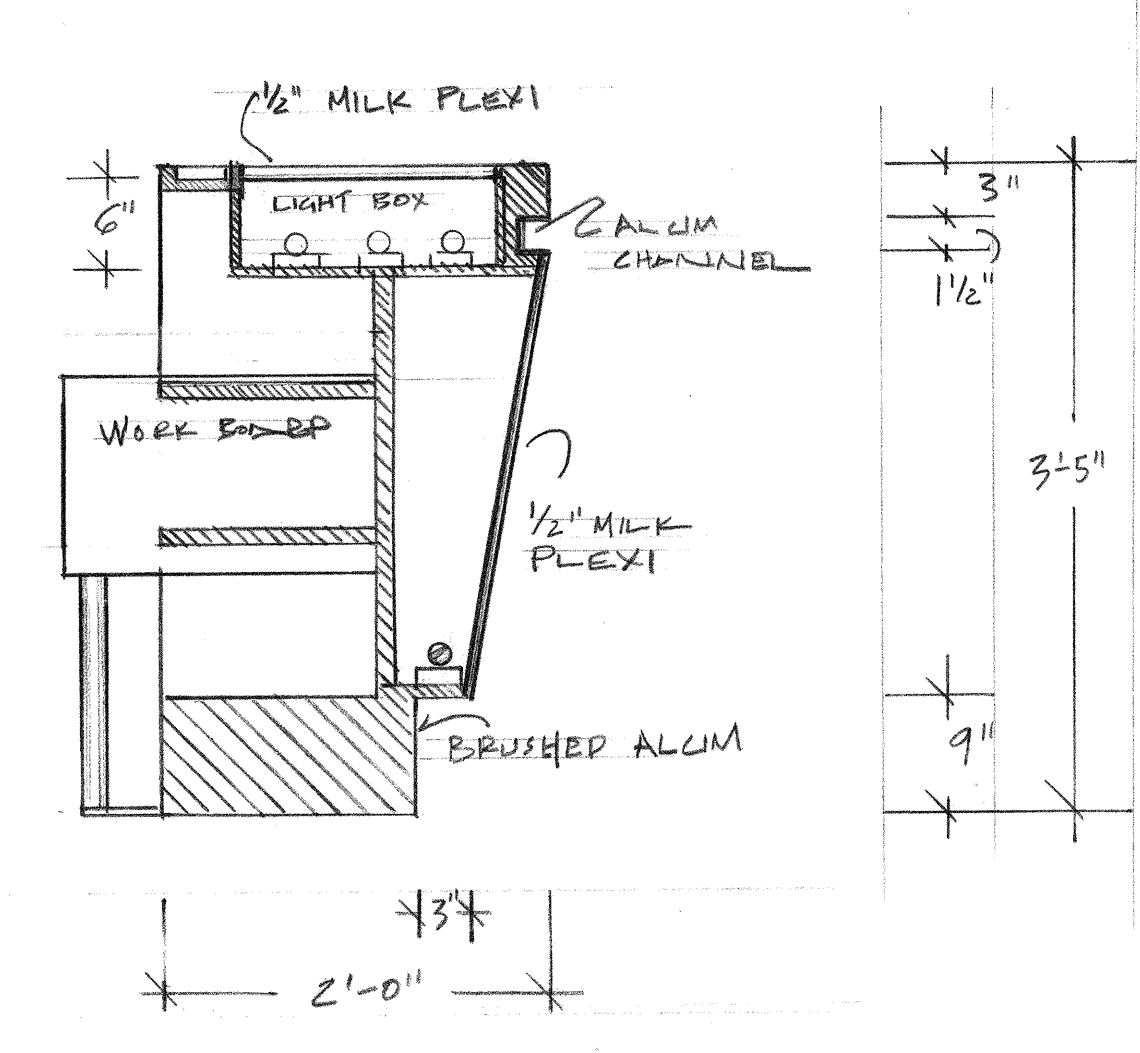

**A-A SECTION A-A**  
SCALE 1"=1'-0"

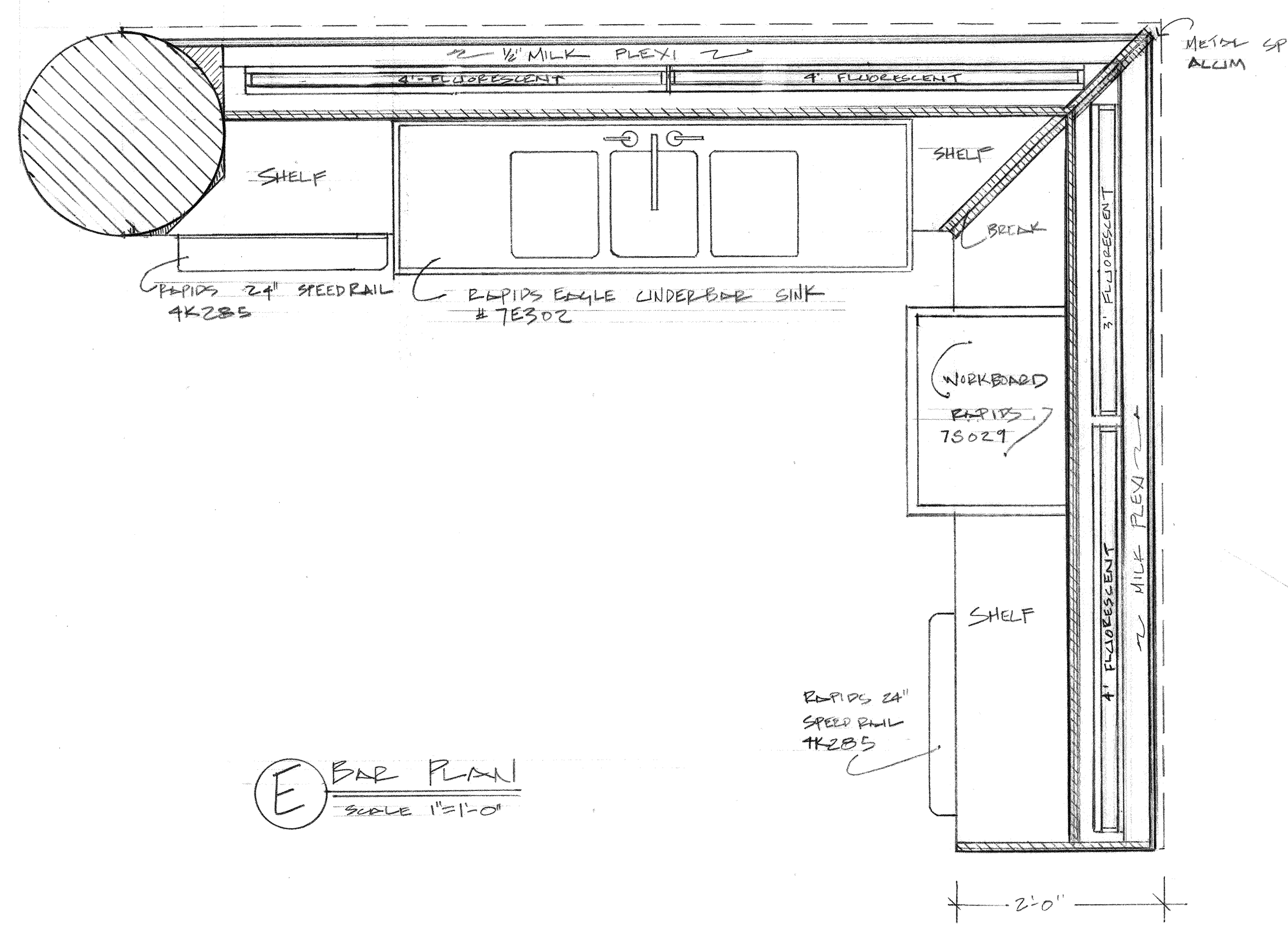

**E BAR PLAN**  
SCALE 1"=1'-0"

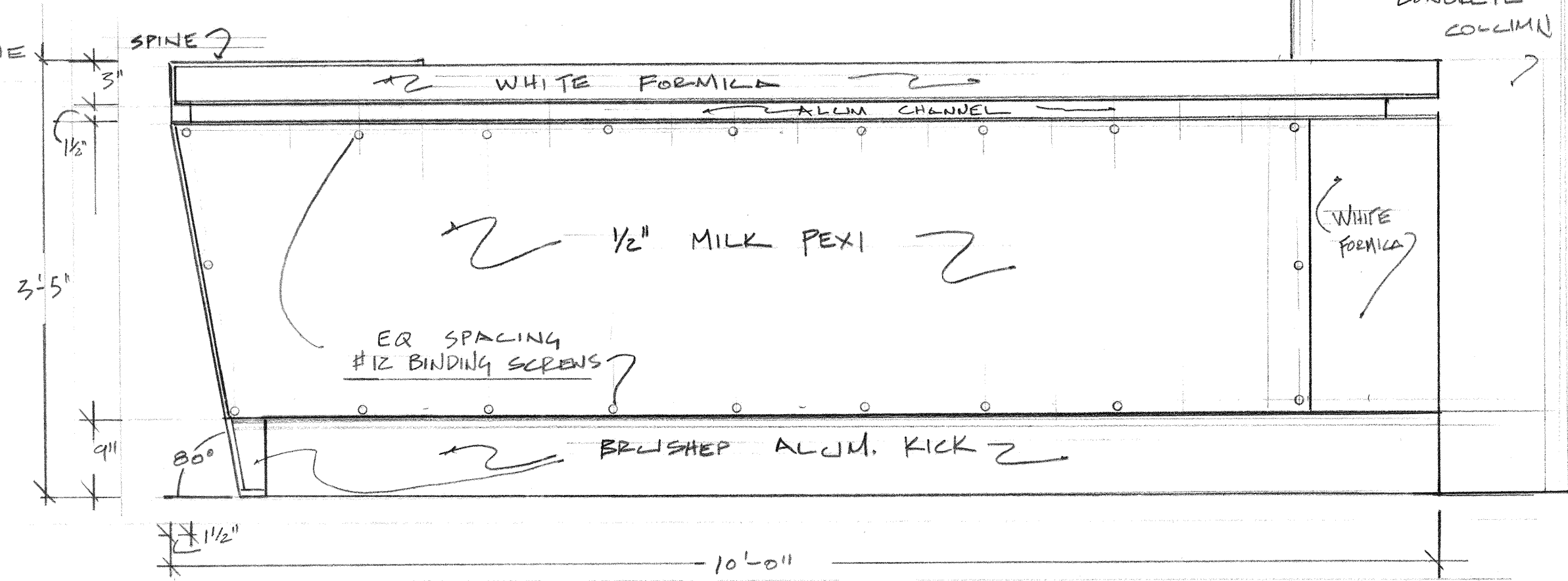

**F U.S. BAR FACE**  
SCALE 1"=1'-0"

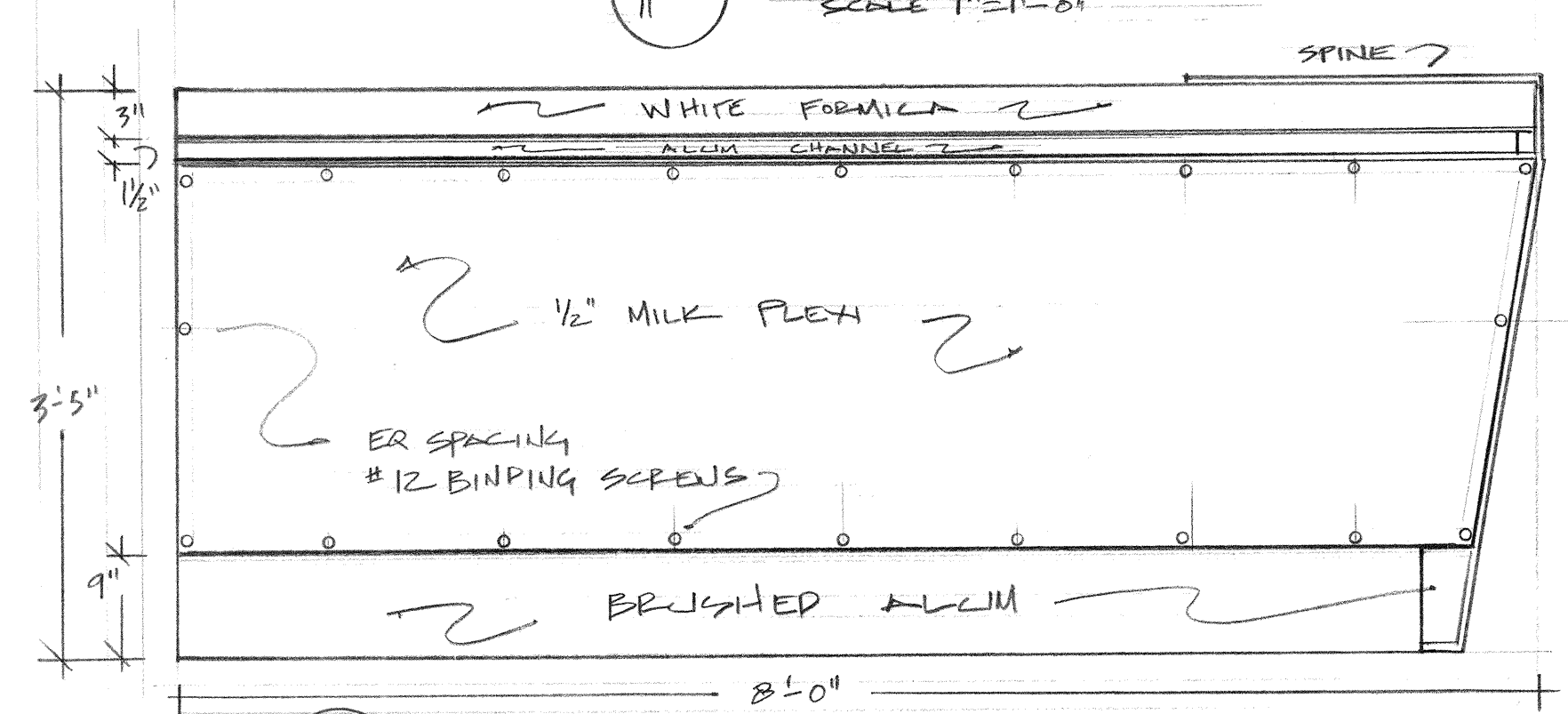

**G SL BAR FACE**  
SCALE 1"=1'-0"

UNION STAMP  S.D. 1104 SCENIC DESIGNER M. F.	<b>AMERICAN BROADCASTING COMPANIES</b> abc		DRAWING NO. 1	
	PROD.: ALL MY CHILDREN		STUDIO 23 TV	
	SET: CONFUSION BAR			OF
	SCALE: 1"=1'-0"	DEL. DATE: 6-7-06		
	DRAWN: DATE: 5-26-06	PROD. DATE: 6-11-06		
DESIGNER: R. MONET		DRAFTSMAN: M. F.		