

**E. D. S. RIGHT WINGS**  
SCALE 1/2" = 1'-0"

**F. S. R. STEPS**  
SCALE 1/2" = 1'-0"

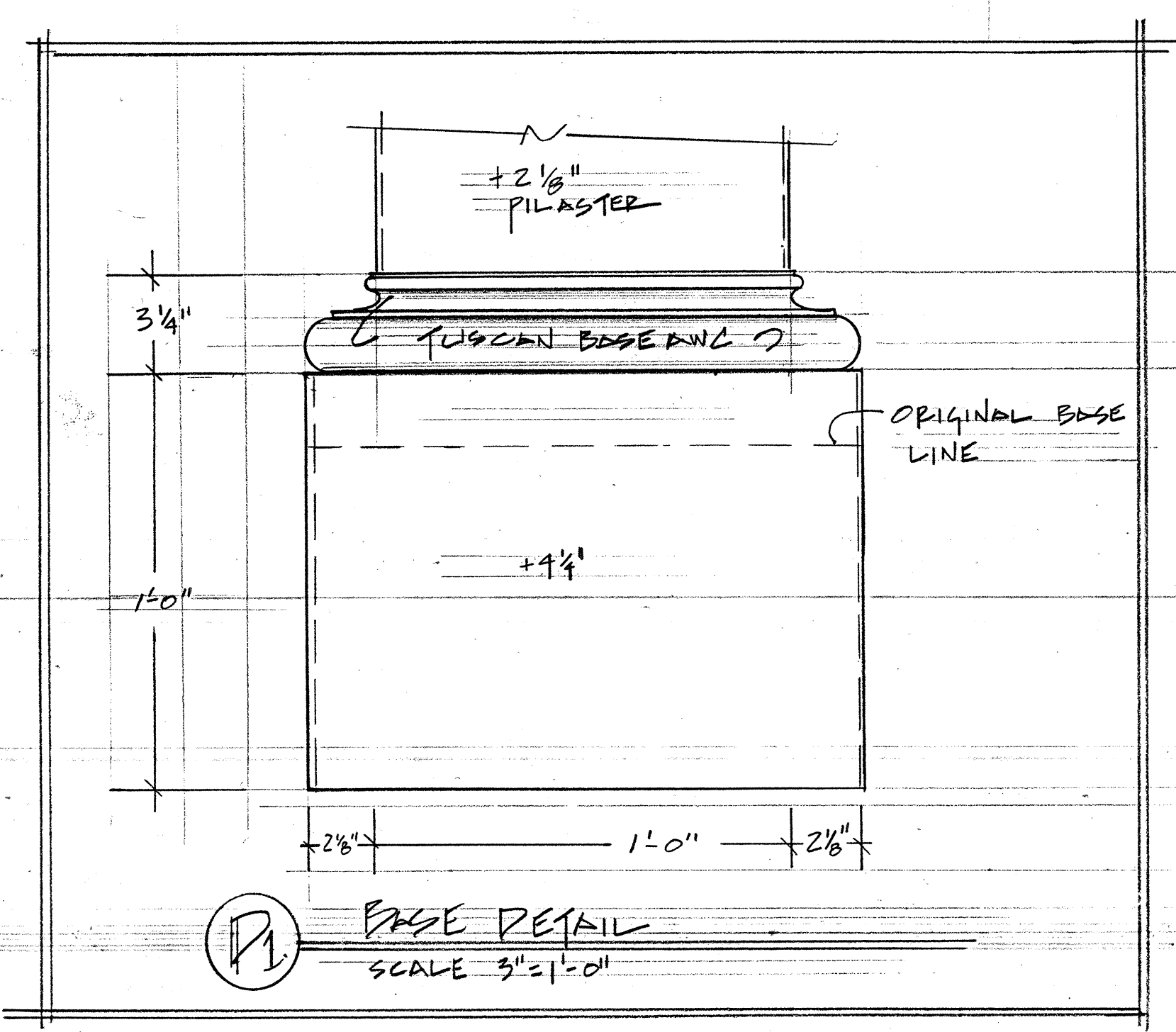
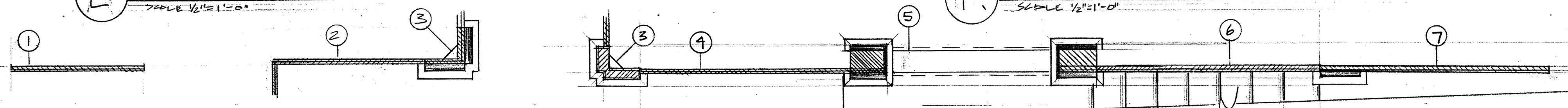

**REVISED**  
12-22-05

UNION STAMP  S.D. 1104 SCENIC DESIGNER	AMERICAN BROADCASTING COMPANIES <b>abc</b>		DRAWING NO. <b>5</b>
	PROD: <b>ALL MY CHILDREN</b>	STUDIO <b>TV 23</b>	OF <b>5</b>
	SET: <b>MANSION BALLROOM</b>		
	SCALE: 1/2" = 1'-0"	DEL. DATE: 1-13-06	
	DRAWN: 12-20-05	PROD. DATE: 1-16-06	
DESIGNER: <b>E. VANET</b>	DRAFTSMAN: <b>M. FAHER</b>		



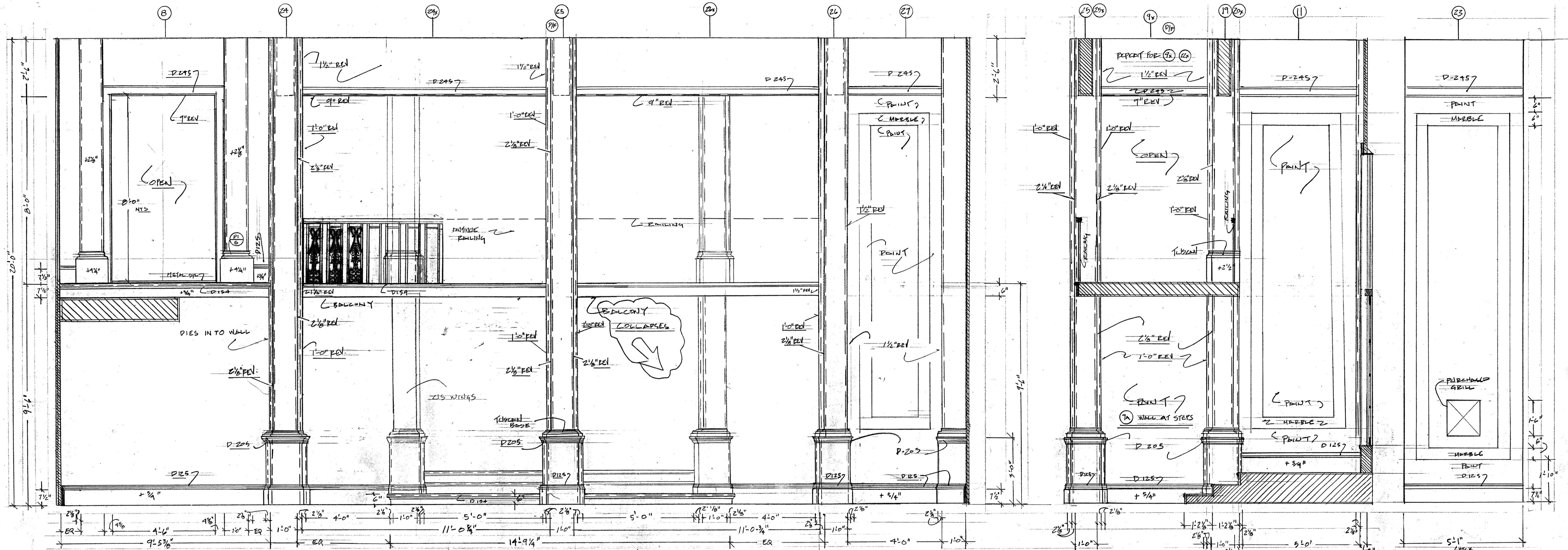

UP STAGE BALCONY  
SCALE 1/2" = 1'-0"

SECTION A-A  
SCALE 1/2" = 1'-0"

SL WINDOW  
SCALE 1/2" = 1'-0"

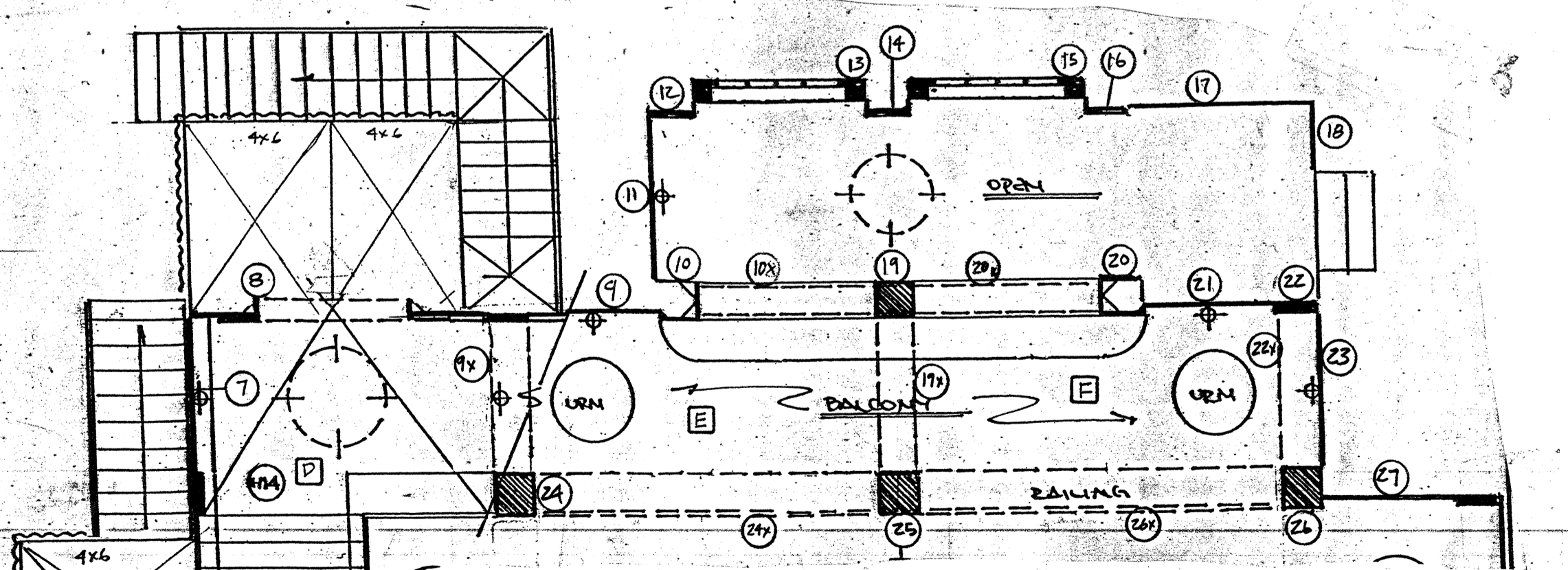
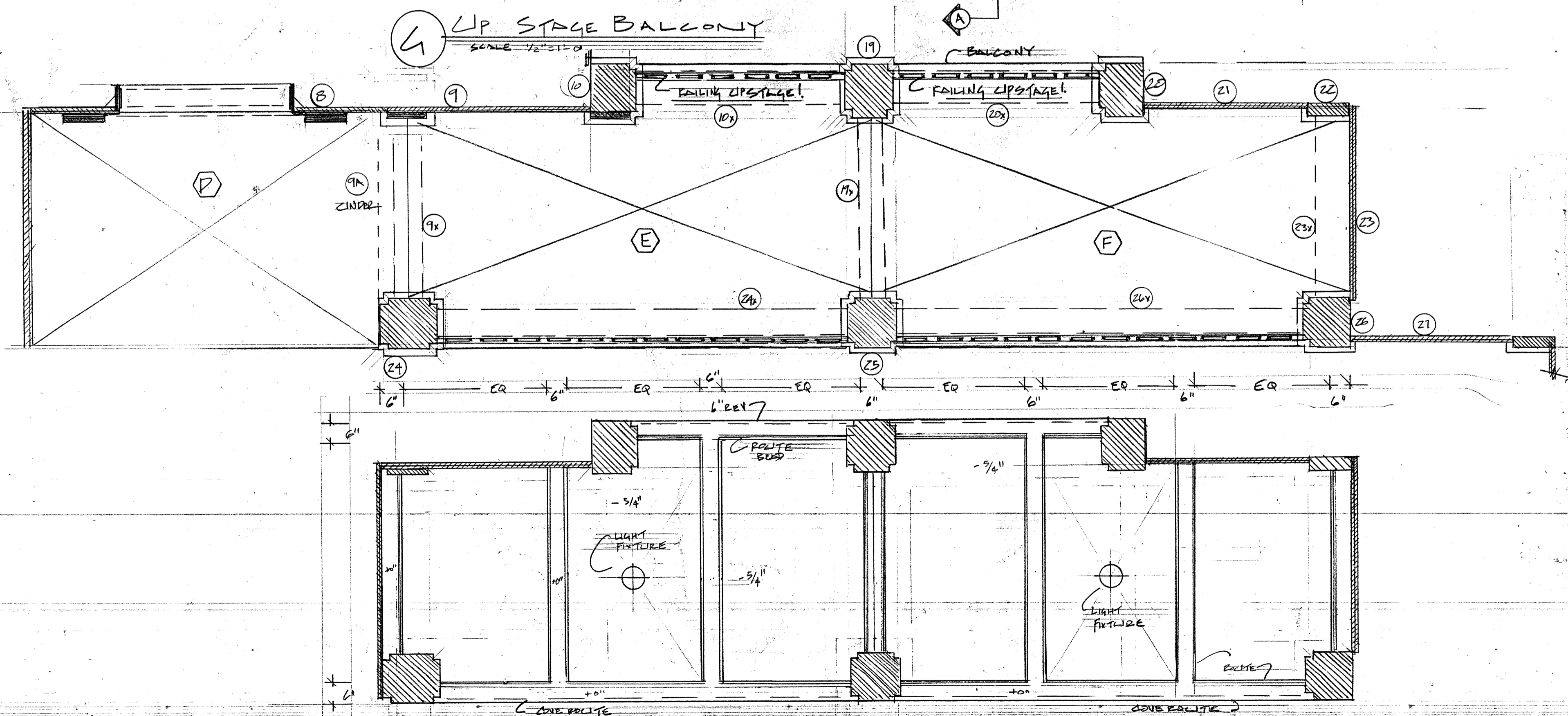

MANION BALLROOM

UNION STAMP  S.D. 1104 SCENIC DESIGNER 1102	AMERICAN BROADCASTING COMPANIES <b>abc</b>		DRAWING NO. 6
	PROD.: ALL MY CHILDREN	STUDIO 23 TV	OF 8
	SET: MANSION BALLROOM		
	SCALE: 1/2" = 1'-0"	DEL. DATE: 1-19-06	
	DRAWN: DATE: 12-20-05	PROD. DATE: 1-17-06	
DESIGNER: E. MOONEY		DRAFTSMAN: V. FAHRER	

RE-REVISED  
1-4-06



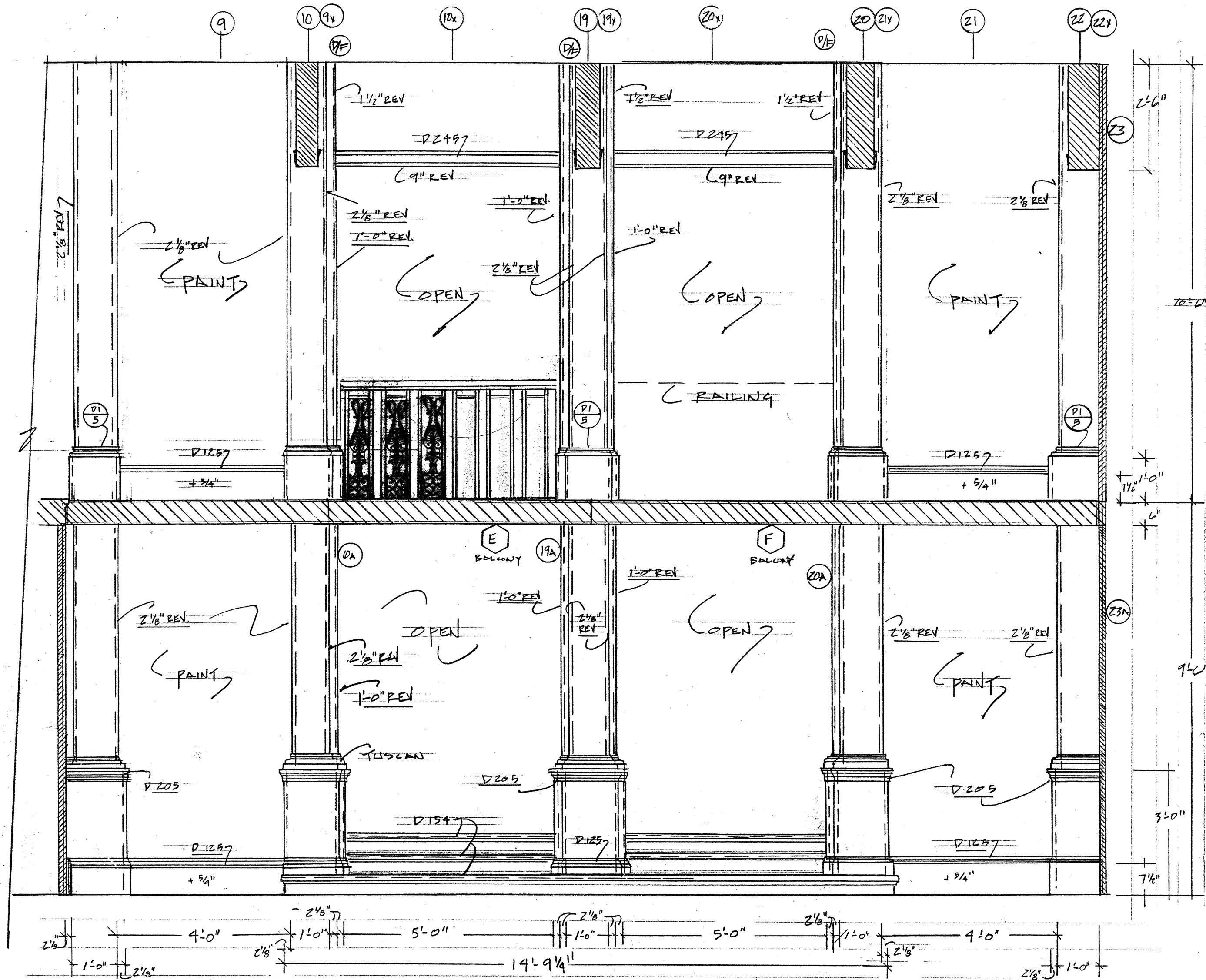

H UP STAGE TERRACE  
SCALE 1/2"=1'-0"

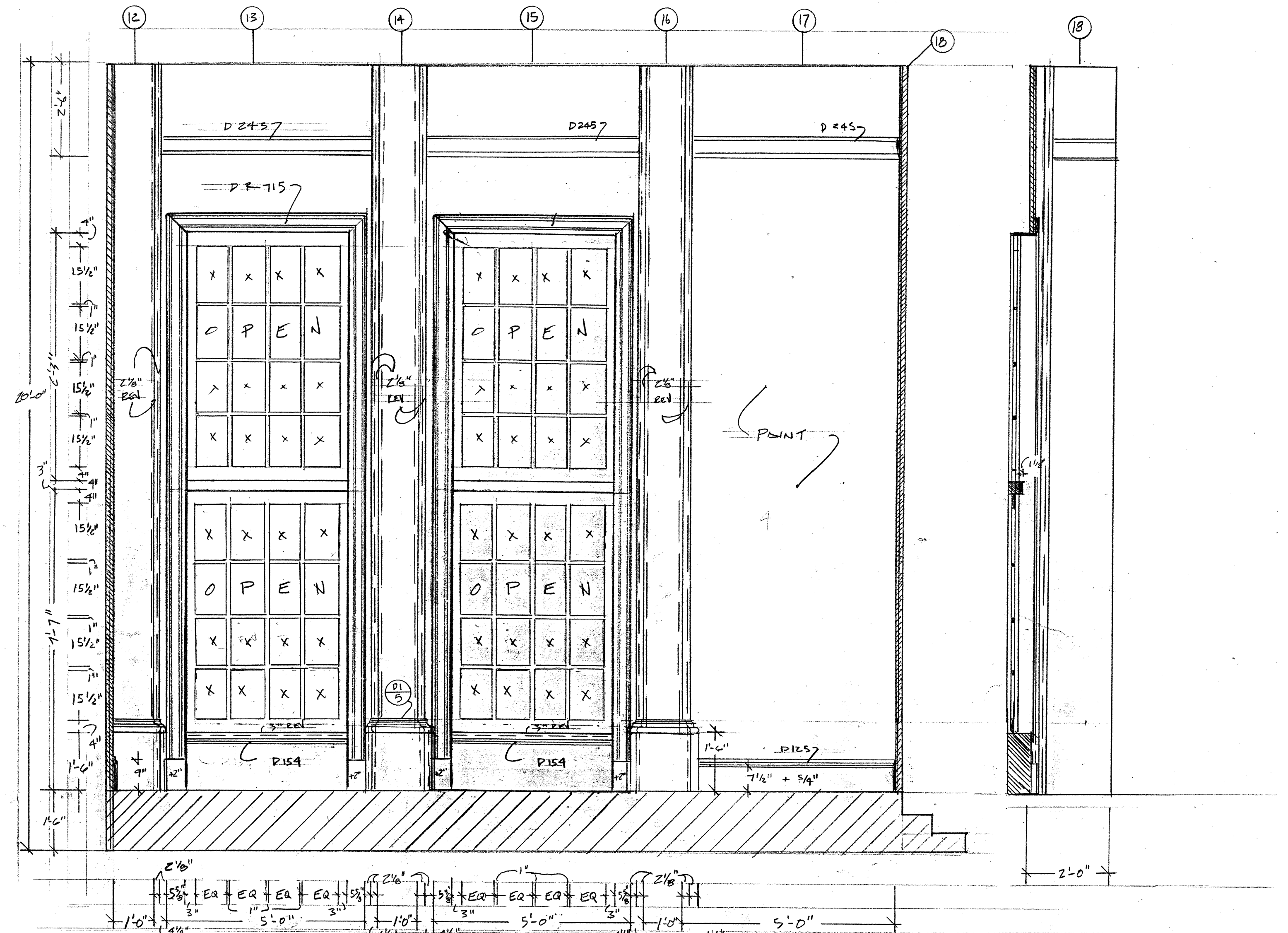

I S WINDOWS  
SCALE 1/2"=1'-0"

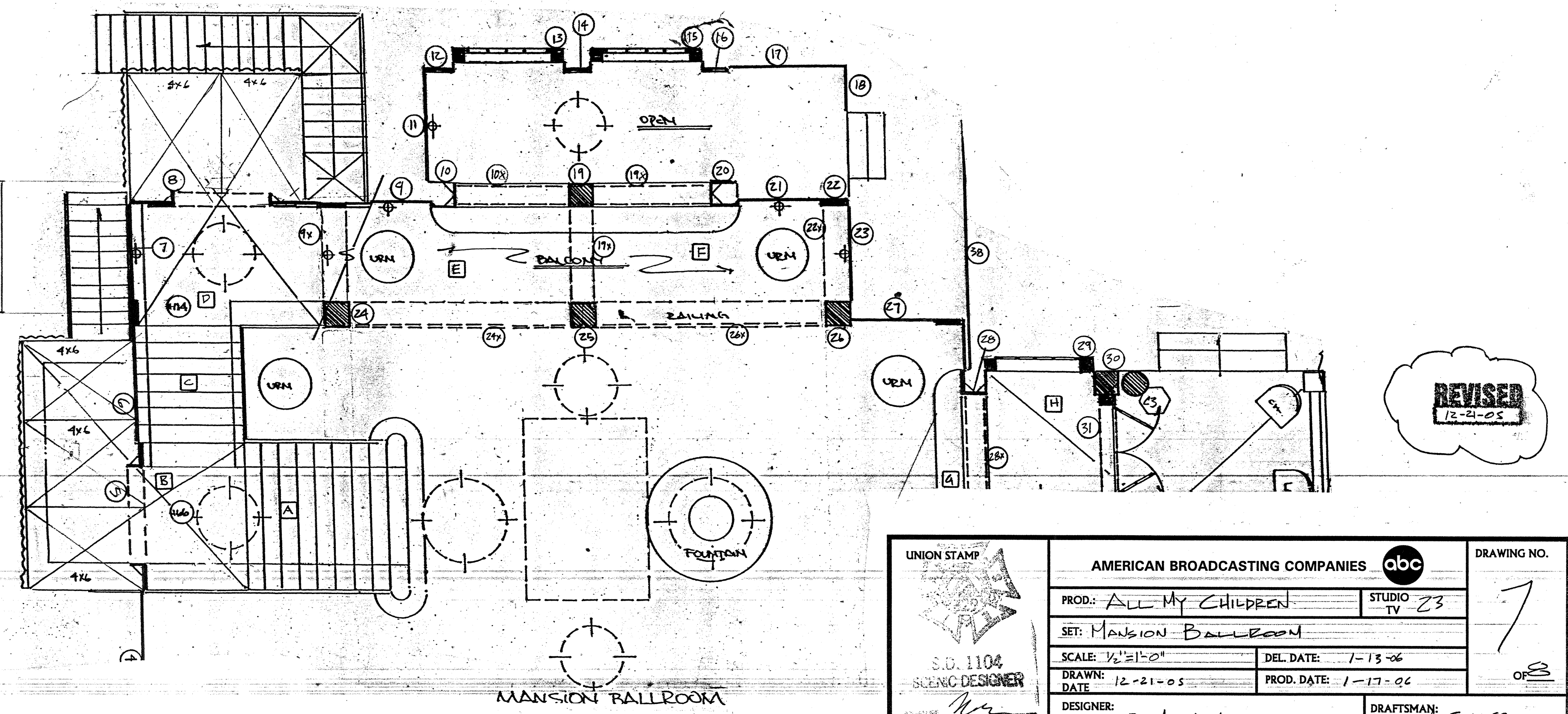
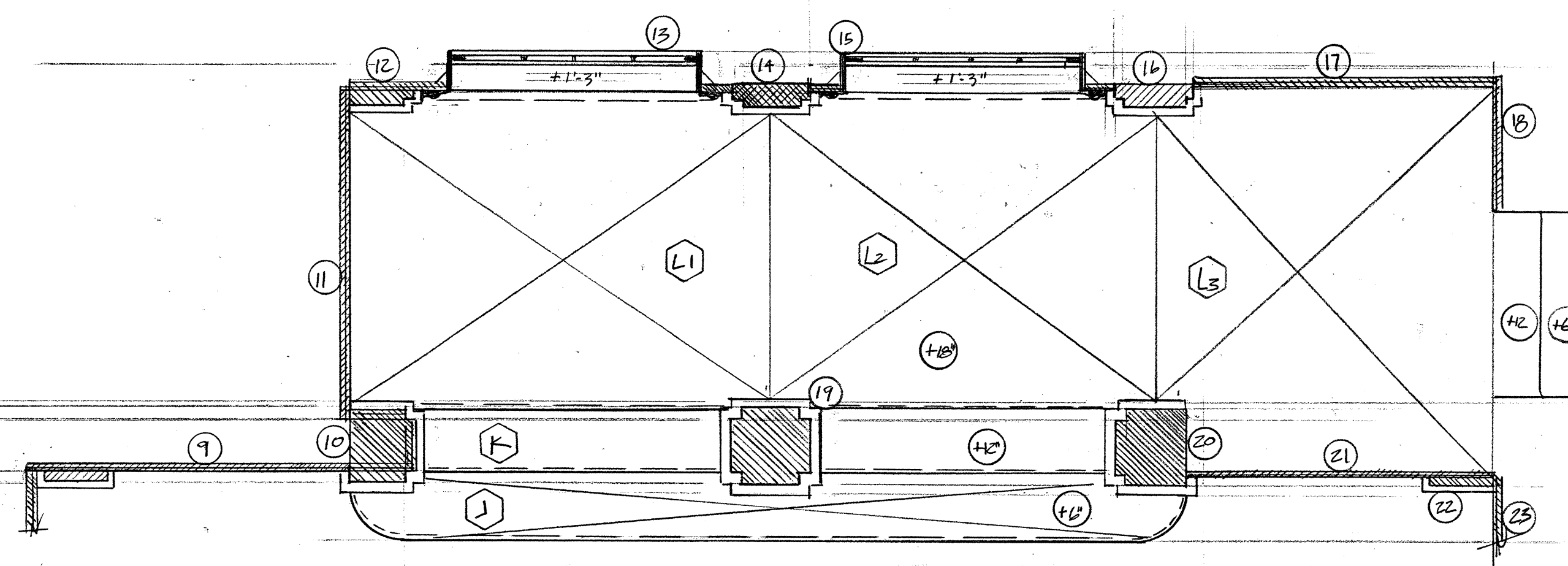

UNION STAMP  S.D. 1104 SCENIC DESIGNER 	AMERICAN BROADCASTING COMPANIES <b>abc</b>		DRAWING NO. 7
	PROD.: ALL MY CHILDREN		STUDIO TV-23
	SET: MANSION BALLROOM		DEL. DATE: 1-13-06
	SCALE: 1/2"=1'-0"		PROD. DATE: 1-17-06
	DRAWN: DATE: 12-21-05		DRAFTSMAN: M. FISHER
DESIGNER: E. MURPHY		OFS	



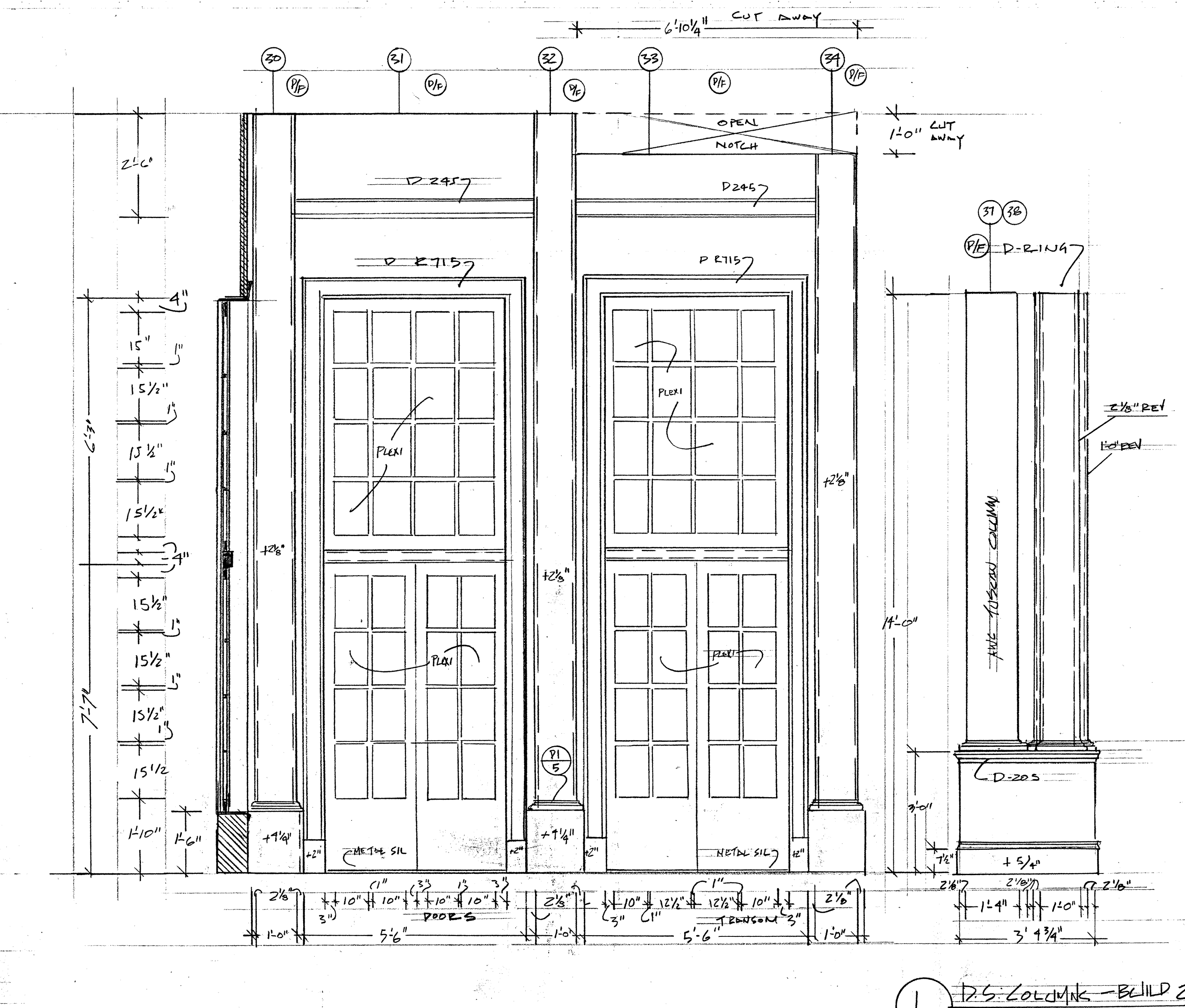
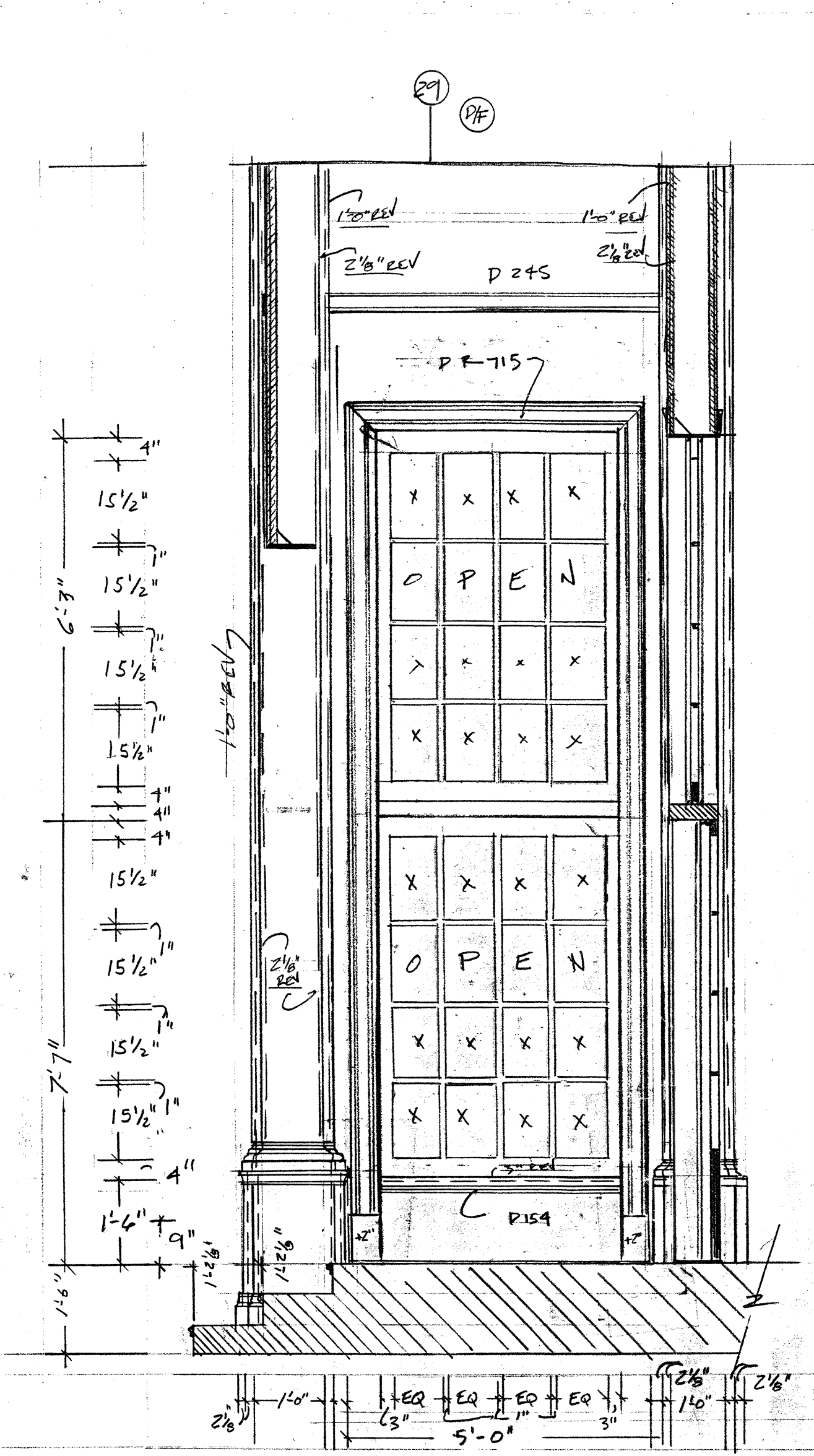
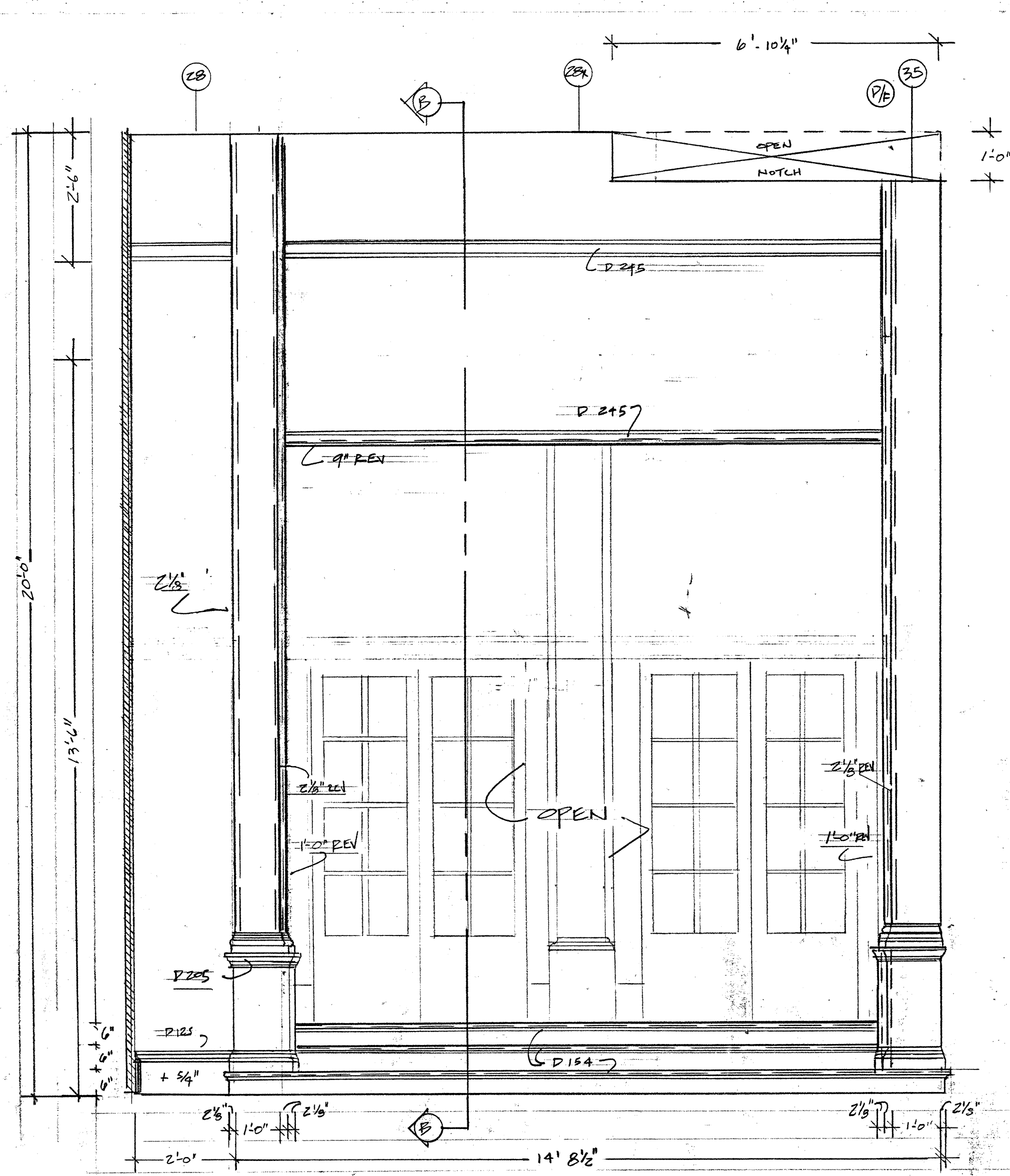

J DOOR ARCHWAY  
SCALE 1/2" = 1'-0"

B-D SECTION B-D  
SCALE 1/2" = 1'-0"

K TERRACE DOORS  
SCALE 1/2" = 1'-0"

L 25' COLUMN - BUILD 2  
SCALE 1/2" = 1'-0"

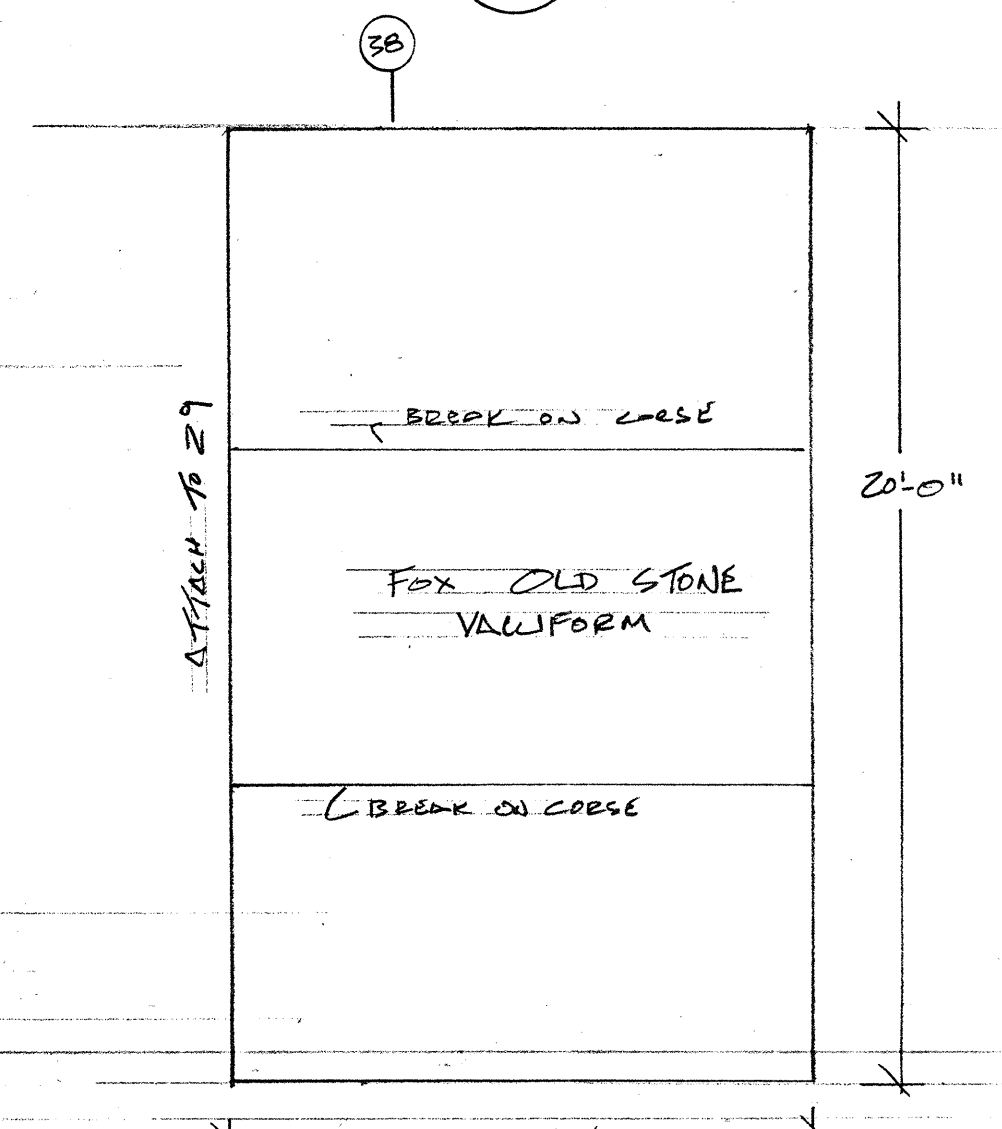
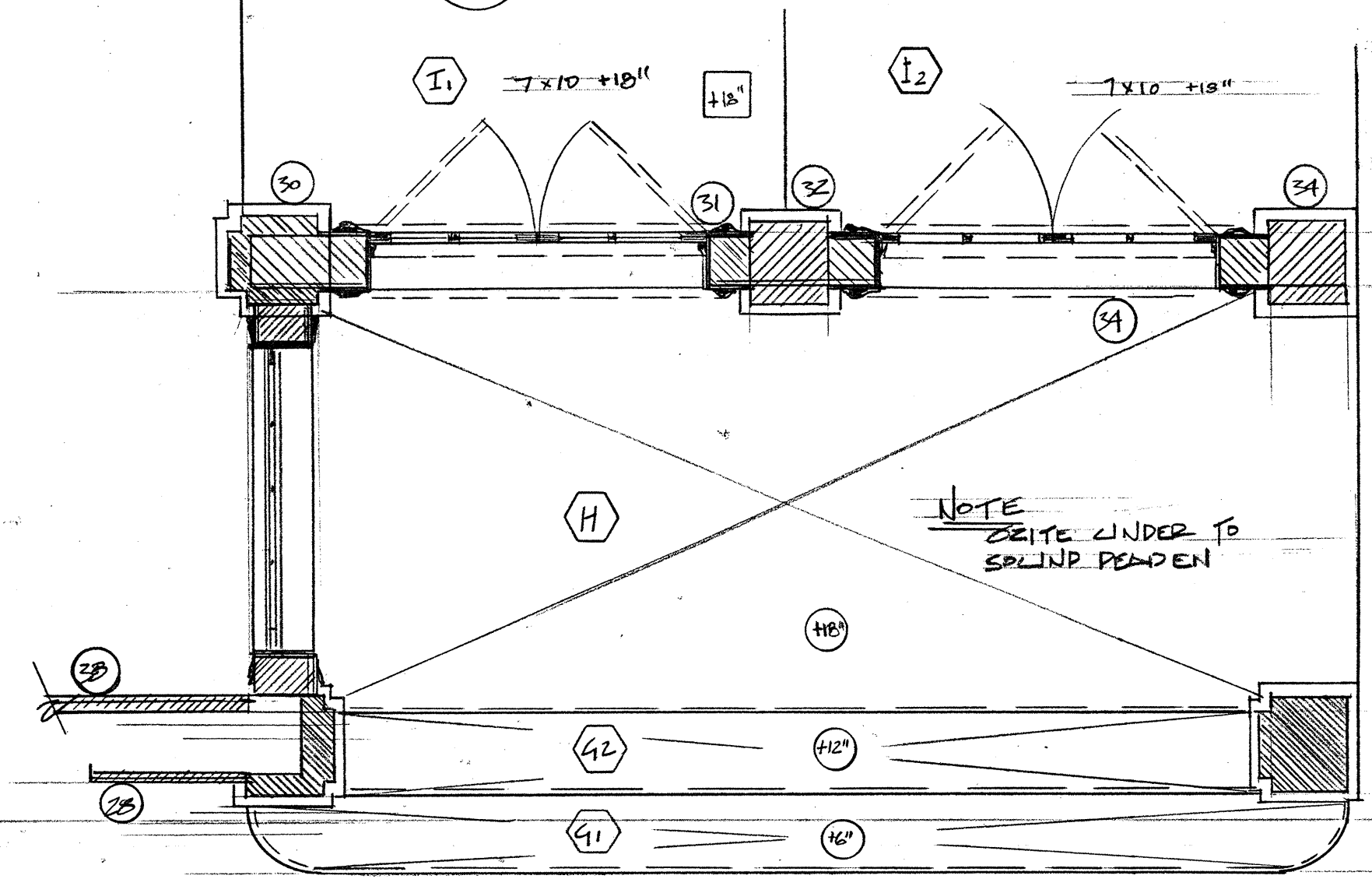

M BRICK WALL  
SCALE 1/2" = 1'-0"

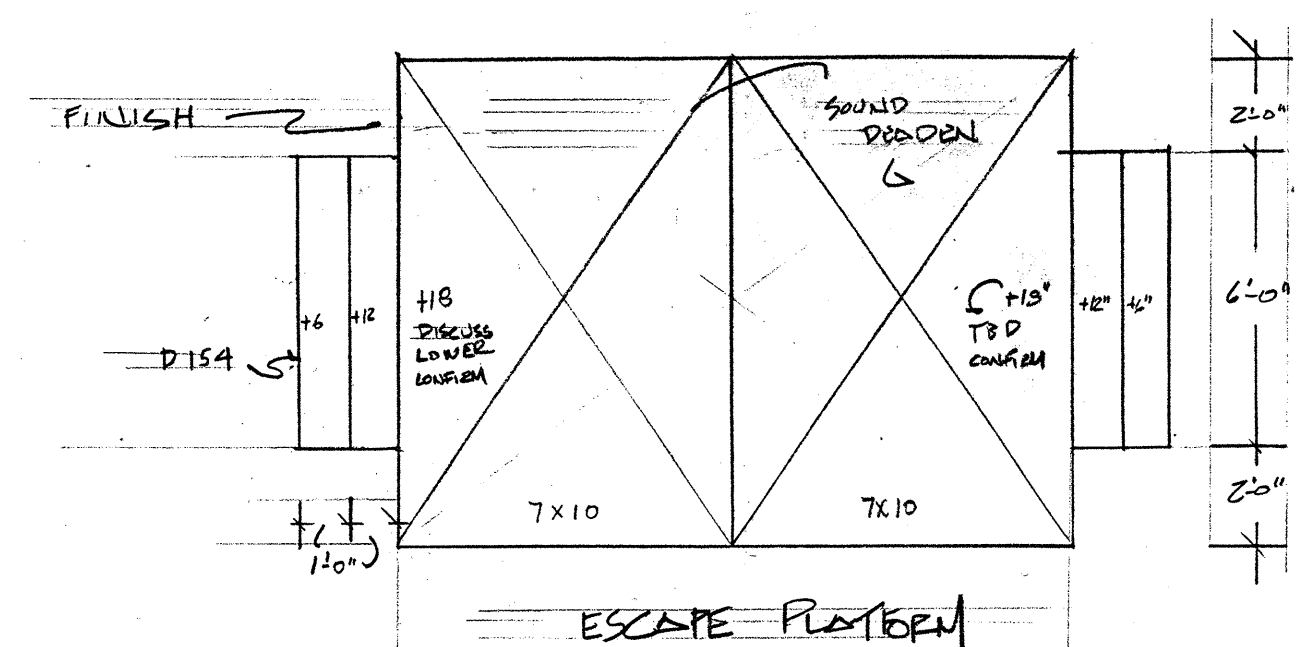
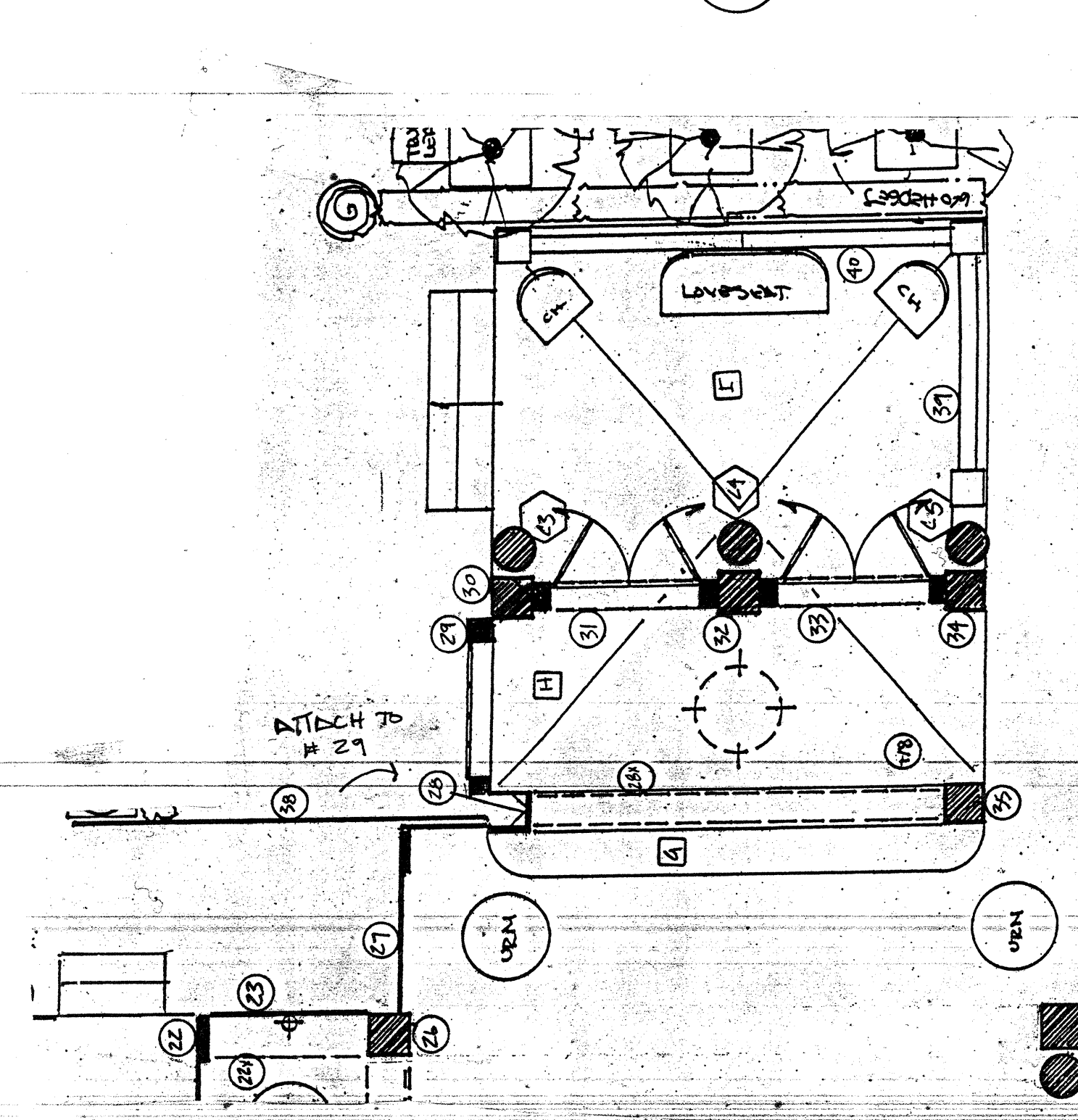

RE REVIS  
1-25-26

UNION STAMP  S.D. 1104 SCENIC DESIGNER DESIGNER: R. MANNING	AMERICAN BROADCASTING COMPANIES <b>abc</b>		DRAWING NO. 8	
	PROD.: ALL MY CHILDREN	STUDIO TV 23	OF 2	
	SET: MANSION EXIT ROOM	SCALE: 1/2" = 1'-0"	DEL. DATE: 1-17-26	
	DRAWN: R. MANNING	DATE: 1-21-26	PROD. DATE: 1-17-26	
	DRAFTSMAN: M. FRANK			



BUILD 1 REAL AND 2 FAKE VERSIONS OF THIS SECTION OF STEPS  
 WHEN STAIRS BREAKAWAY WE NEED TO SEE BREAKAWAY CONSTRUCTION FOR REALISTIC LOOK

HANDRAILS = DYKES  
 PJ NEWMAYER  
 # N6519 SC  
 BALUSTER  
 DETAIL SEE  
 SHT # 2

STILL DISCUSS  
 BEST METHOD OF  
 BREAKAWAY STEPS  
 WITH STUNT PEOPLE

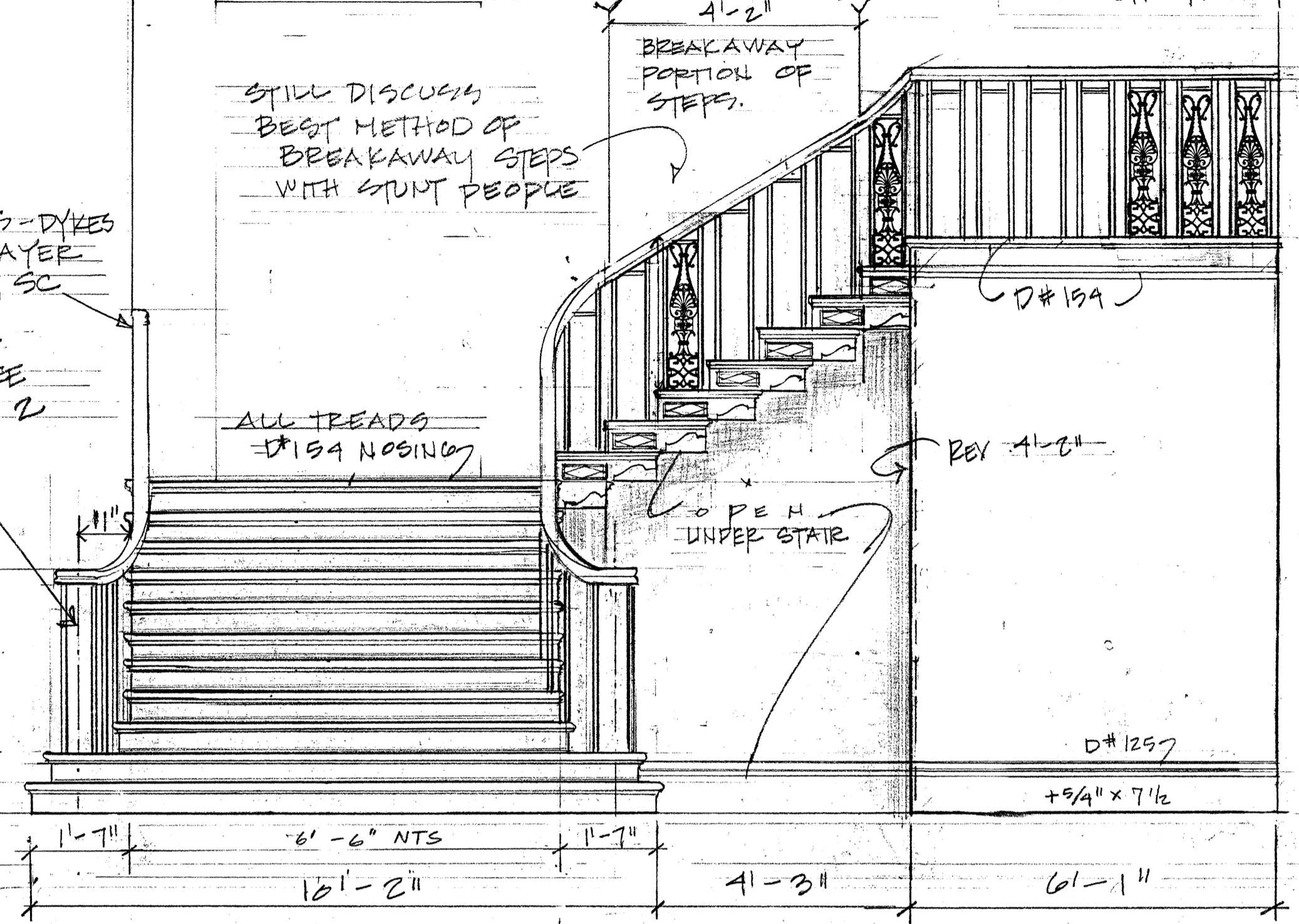

(A) STAIR FACE

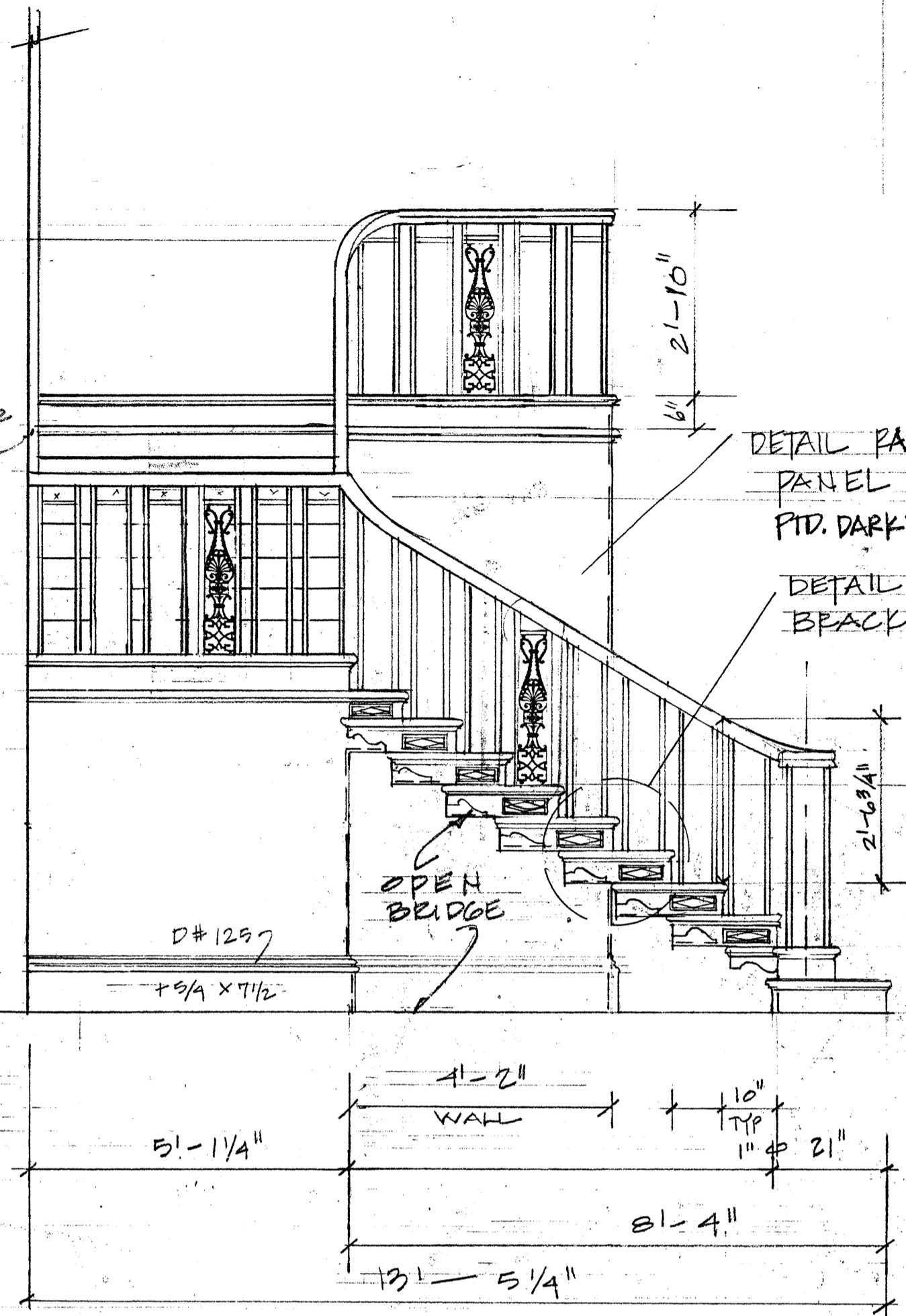

(B) SIDE VIEW STAIRS L.H.

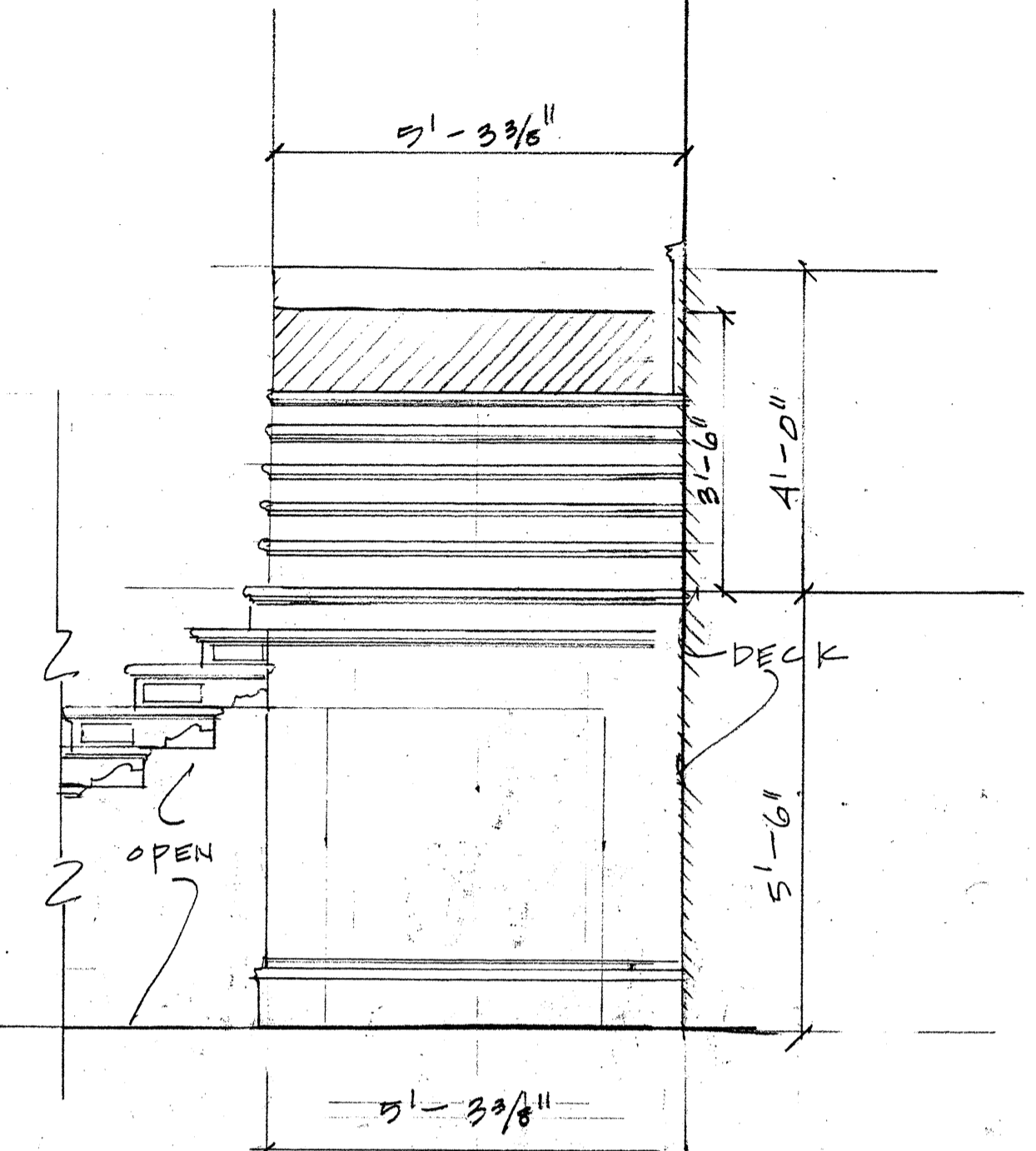

(C) SIDE VIEW STAIRS R.H.  
 UNDER STAIR PLATFORM C

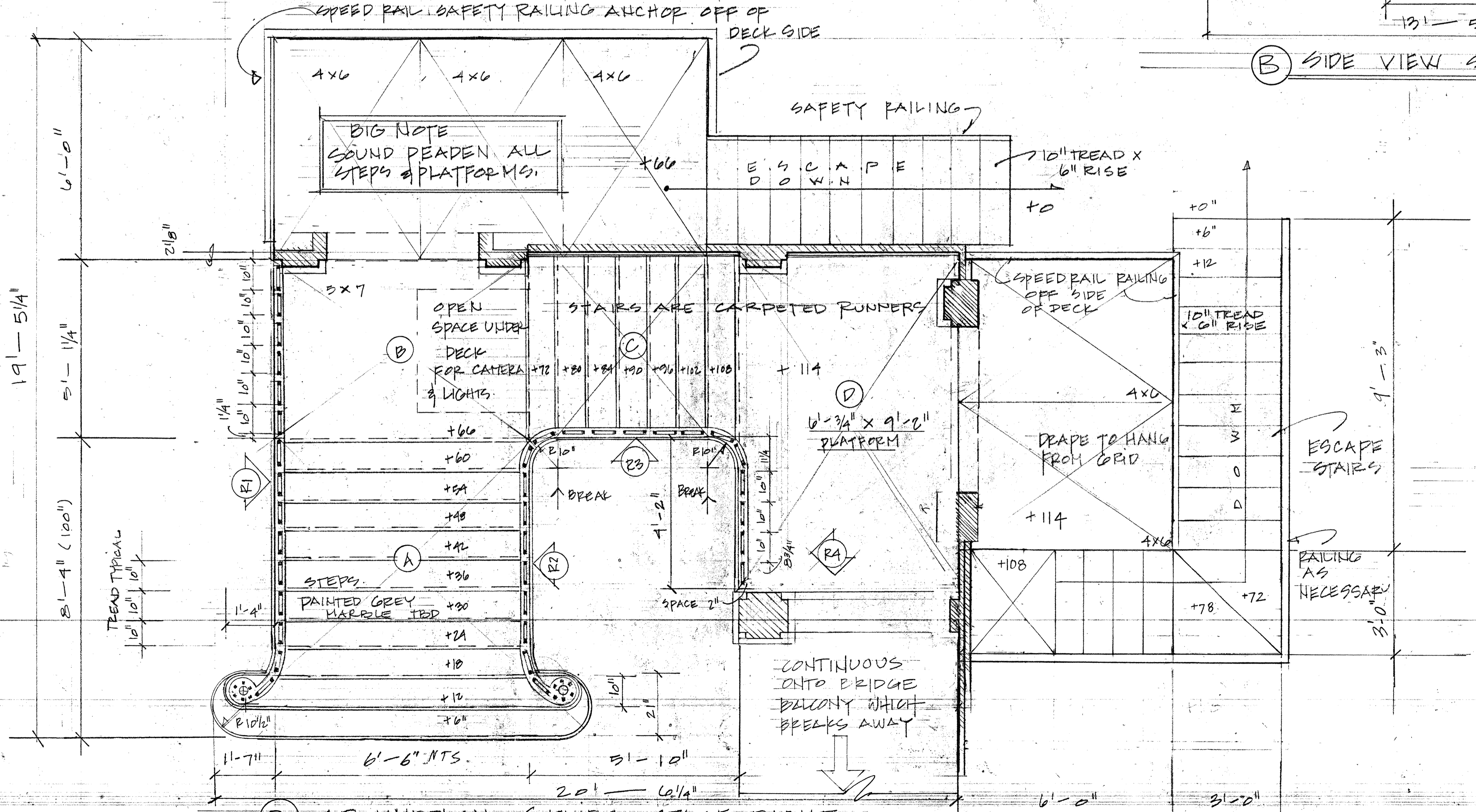

(D) GROUNDPLAN STAIRS STAGE RIGHT

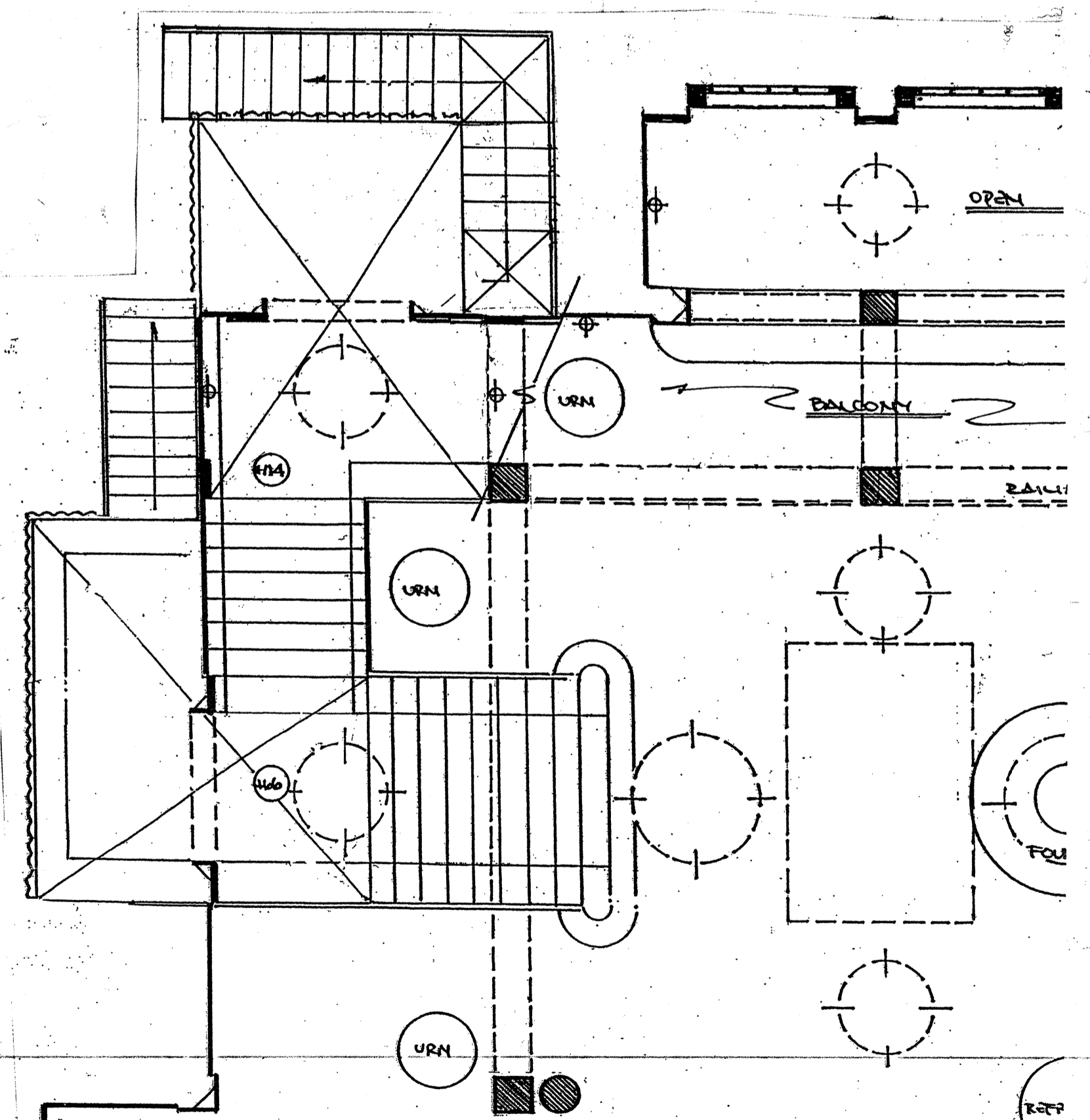

REVISED

UNION STAMP  S.O. 1104 SCENIC DESIGNER 	AMERICAN BROADCASTING COMPANIES <b>abc</b>		DRAWING NO.
	PROD: ALL MY CHILDREN		STUDIO TV 23
	SET: MANSION BALLROOM		OF 8
	SCALE: 1/2" = 1'-0"	DEL. DATE:	PROD. DATE:
	DRAWN: DATE: 12/15/05	DESIGNER: P. MOONEY	DRAFTSMAN: LA BROCK



**Versatile Post with Crown**

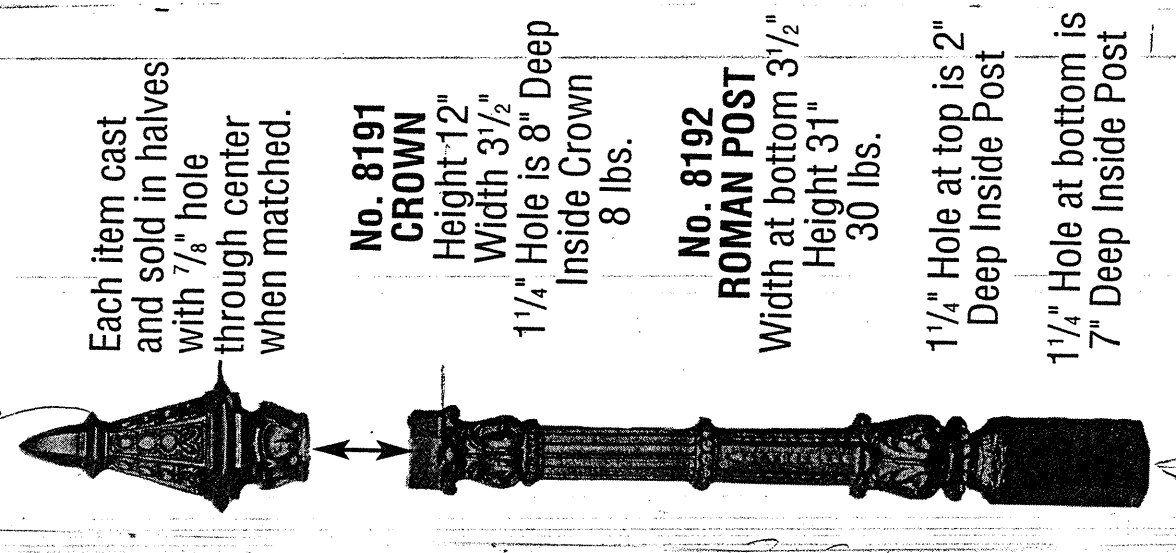

Each item cast and sold in halves with 7/8" hole through center when matched.

**No. 8191 CROWN**  
 Height 12"  
 Width 3 3/4"  
 1 1/2" Hole is 8" Deep Inside Crown  
 8 lbs.

**No. 8192 ROMAN POST**  
 Width at bottom 3 1/2"  
 Height 31"  
 30 lbs.

1 1/4" Hole at top is 2" Deep Inside Post

1 1/4" Hole at bottom is 7" Deep Inside Post

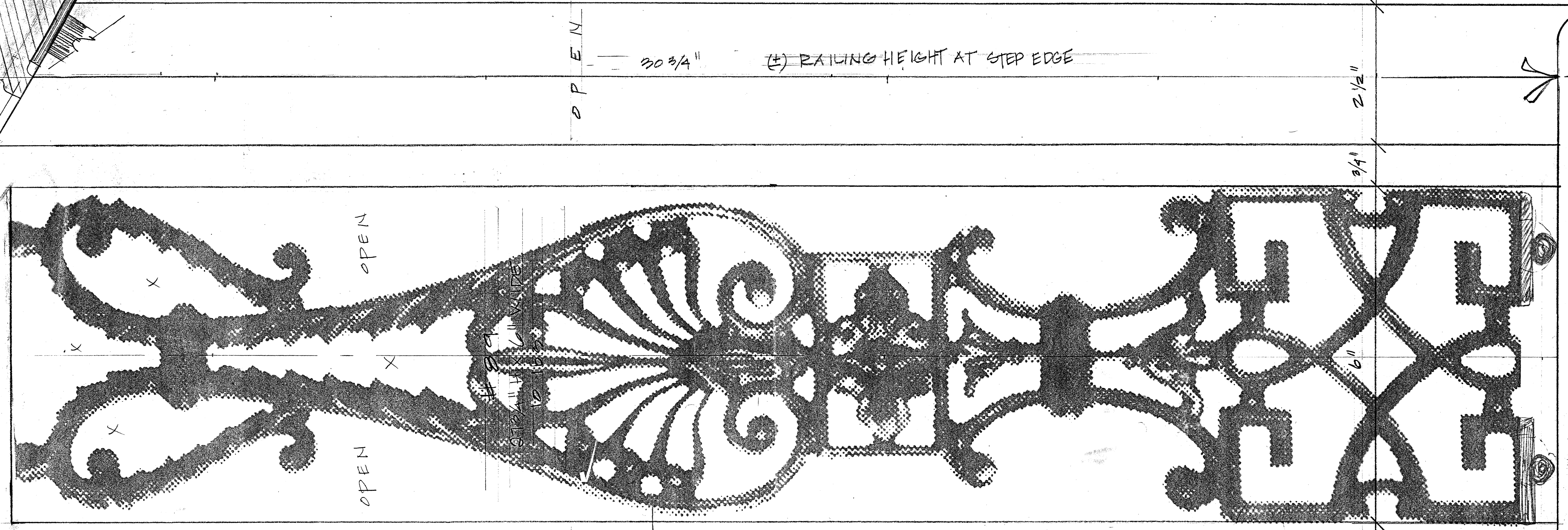
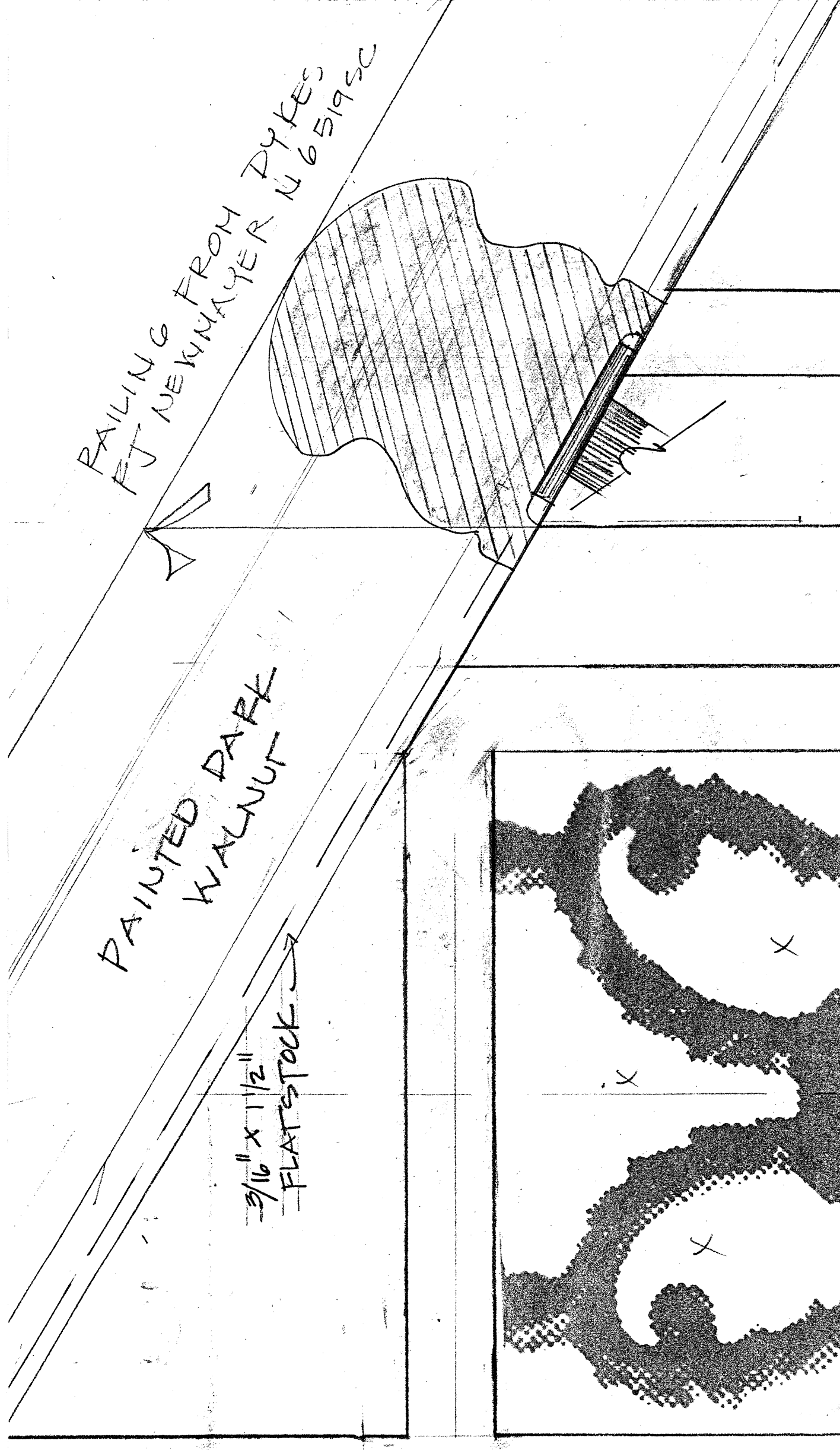
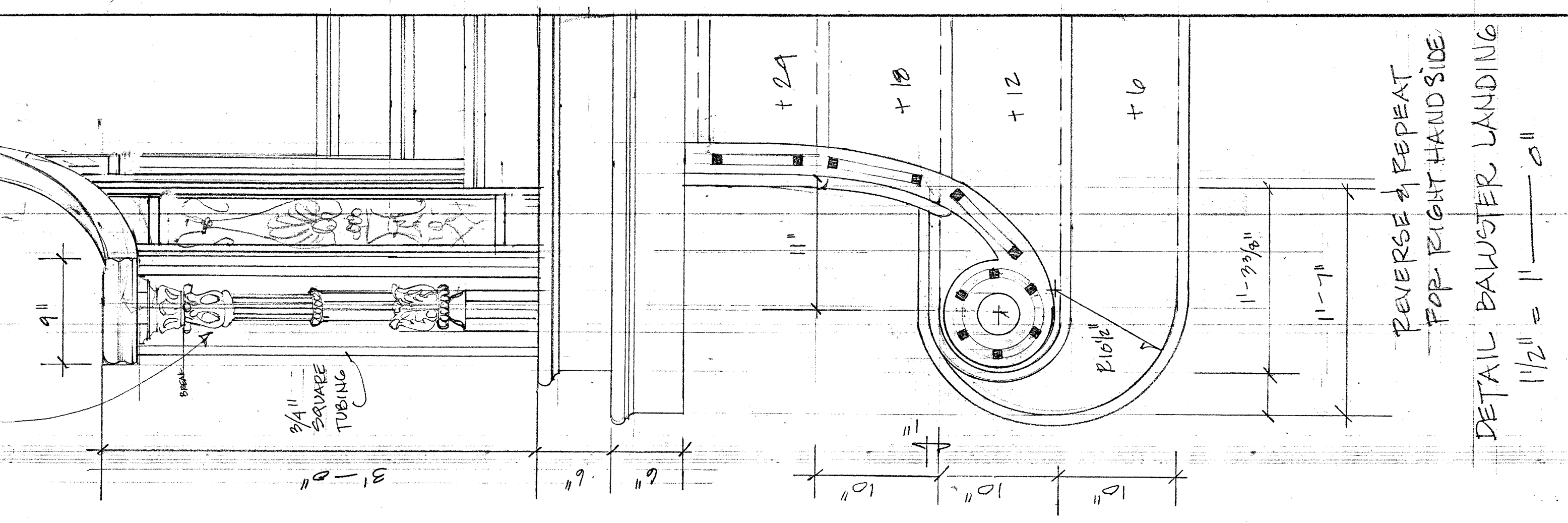

UNION STAMP	AMERICAN BROADCASTING COMPANIES abc		DRAWING NO.
	PROD.: ALL MY CHILDREN	STUDIO TV 23	2
	SET: MANSION BALLROOM		OF 8
SCALE: FULL SIZE	DEL. DATE:		
DRAWN: DATE 12.15.05	PROD. DATE:		
DESIGNER: R. MOONEY	DRAFTSMAN: L. BROCK		

FOR ESTIMATE

10" TREAD

D#154

D#154

OPEN

OPEN

OPEN

OPEN

(E) RAILING HEIGHT AT STEP EDGE



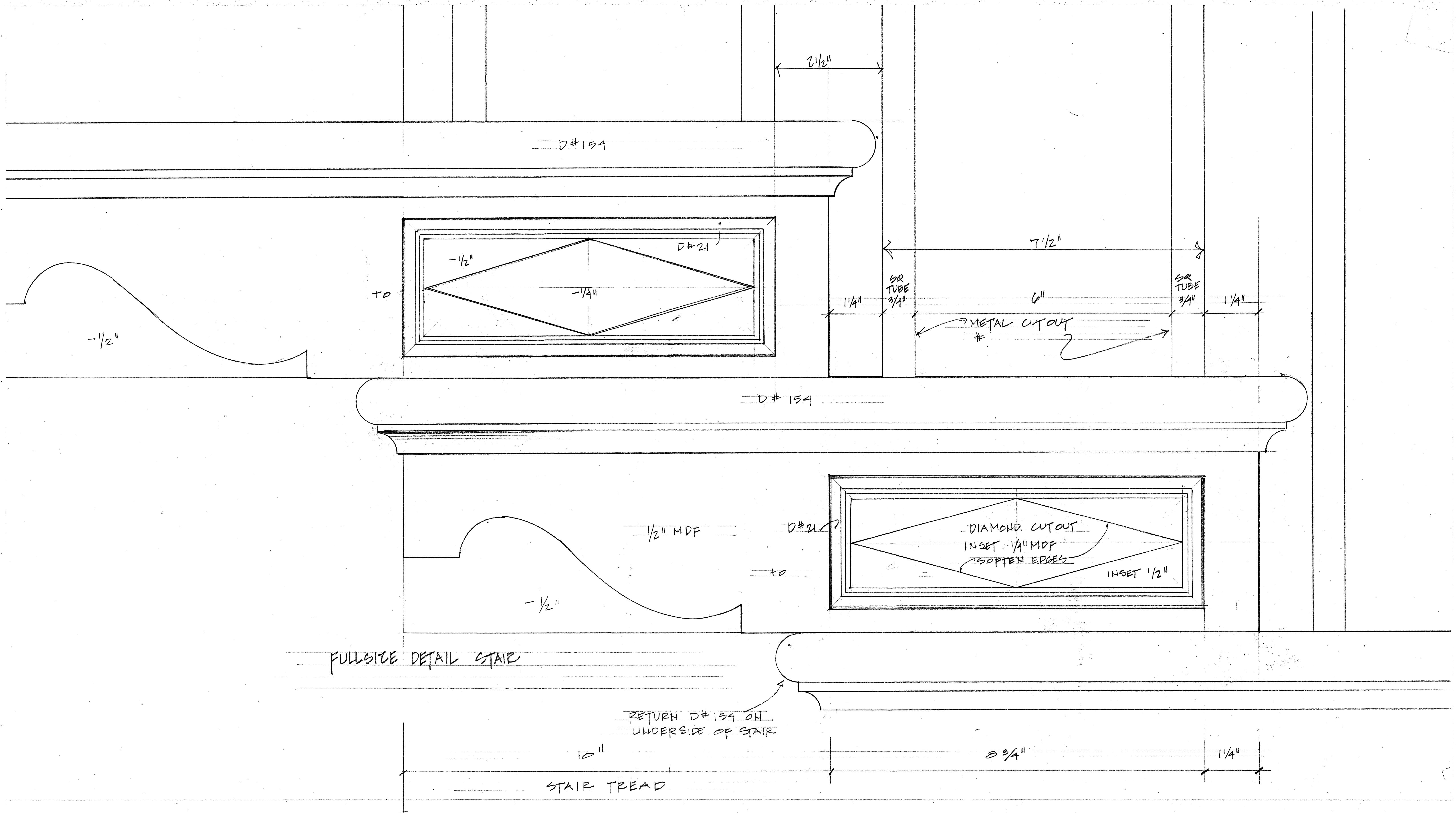

FULLSIZE DETAIL STAIR

RETURN D#154 ON  
UNDERSIDE OF STAIR

STAIR TREAD

UNION STAMP	AMERICAN BROADCASTING COMPANIES		DRAWING NO.
	PROD: ALL MY CHILDREN	STUDIO 23	3 OF 8
	SET: MANSION BALLROOM		
	SCALE: FULLSIZE	DEL. DATE:	
	DRAWN: DATE: 12.15.05	PROD. DATE: 1.15.05	DESIGNER: R. MOONEY

ATE



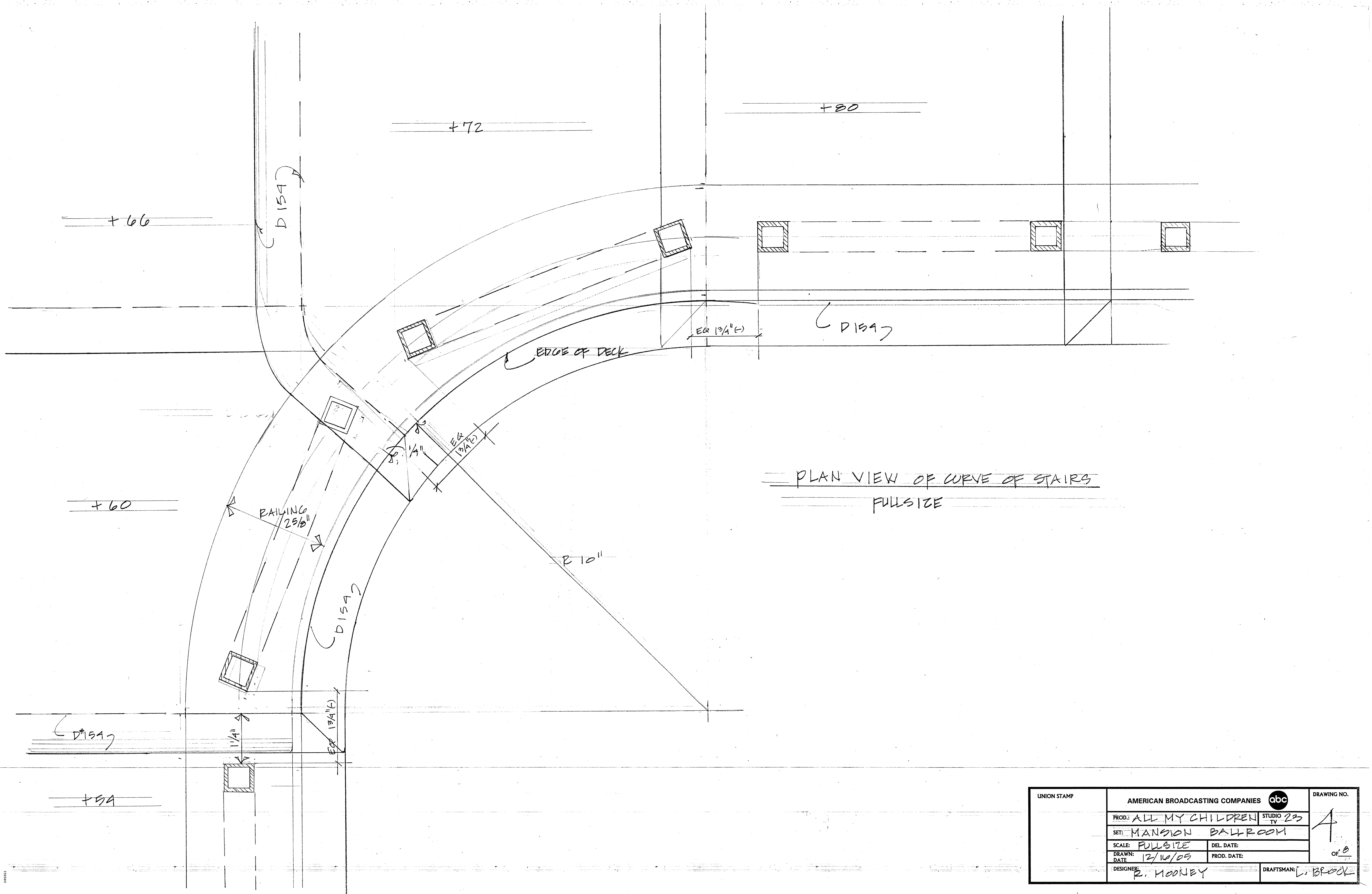

PLAN VIEW OF CURVE OF STAIRS  
FULLSIZE

UNION STAMP	AMERICAN BROADCASTING COMPANIES		DRAWING NO.
	PROD.: ALL MY CHILDREN	STUDIO TV 23	A
	SET: MANSION BALLROOM		
	SCALE: FULLSIZE	DEL. DATE:	OF 0
	DRAWN: DATE: 12/16/05	PROD. DATE:	
DESIGNER: P. MOONEY	DRAFTSMAN: L. BROCK		