

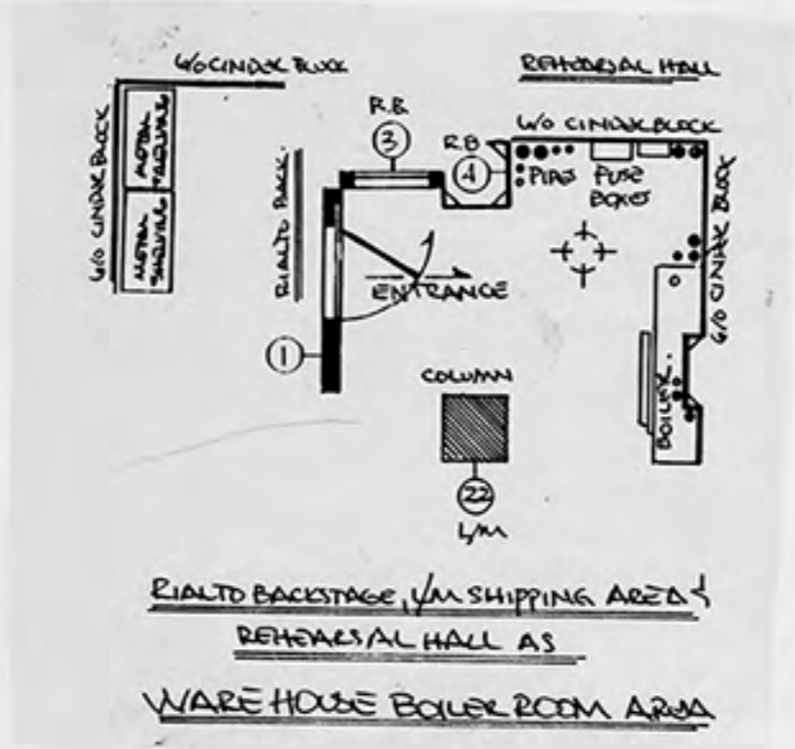

NOTES:
 - SW REFERS TO SCENERY WEST NUMBERS
 - OUTSIDE PIPES TO PURCHASE BOXES + GAUGES
 - BOTTOM DOOR WILL NEED TO BE REPOSITIONED TO LOOK BLOWN APART - DISCUSS -
 - PIPES REPOSITIONED ALSO - DISCUSS -
 - PAINT FUSED IRON - SEE PHOTOS -
 - PIPE - FLEXIBLE METAL - W/PISTON



UNION STAMP  S D 305 SCENIC DESIGNER SIGNATURE: [Signature]	AMERICAN BROADCASTING COMPANIES 		DRAWING NO.
	PROJ: ONE LIFE TO LIVE	STUDIO TV 17	1
SET: BOILER	SCALE: 1"=1'-0"	DEL. DATE: 7/15	OF 1
DRAWN: 7/B	DESIGNER: ROGER MOONEY	PROD. DATE: 7/16	
DRAFTSMAN: [Signature]		DRAFTSMAN: [Signature]	

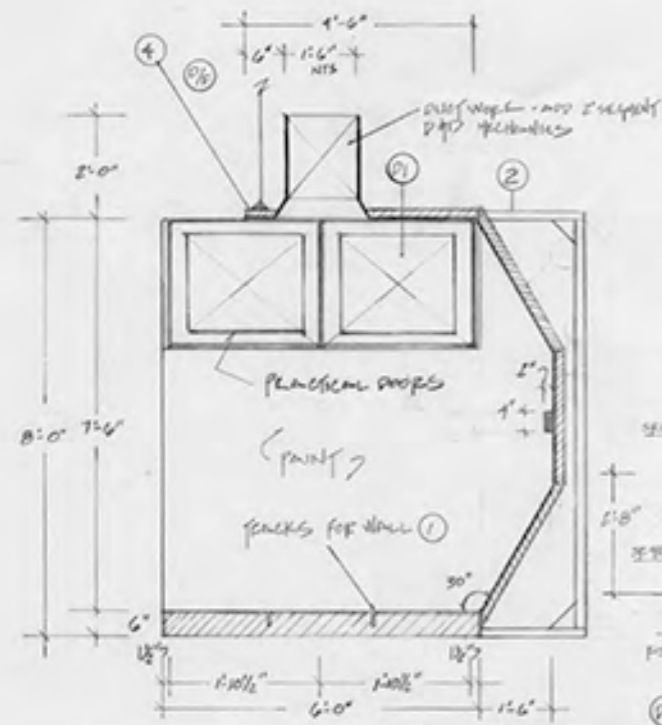

A ENTRANCE
SCALE 1/2" = 1'-0"

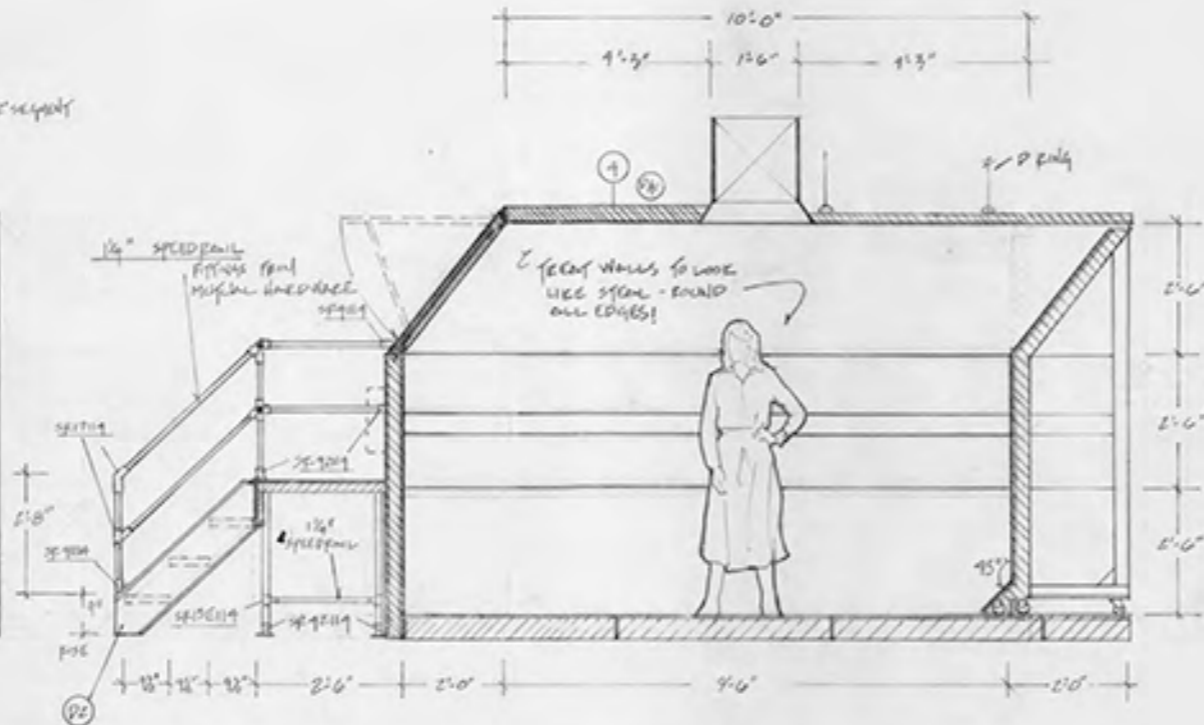

B UPSTAGE WALL
SCALE 1/2" = 1'-0"

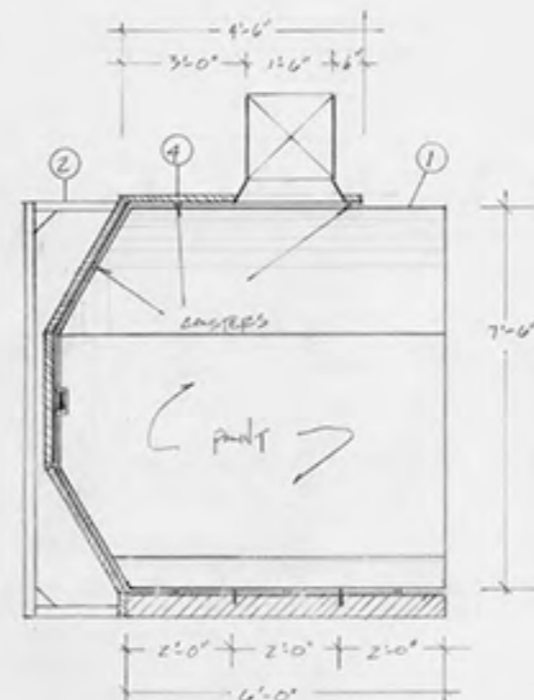

C COMPACTOR WALL
SCALE 1/2" = 1'-0"
- COMPACTOR WALL CASTED & MOVED BY STAGEHANDS

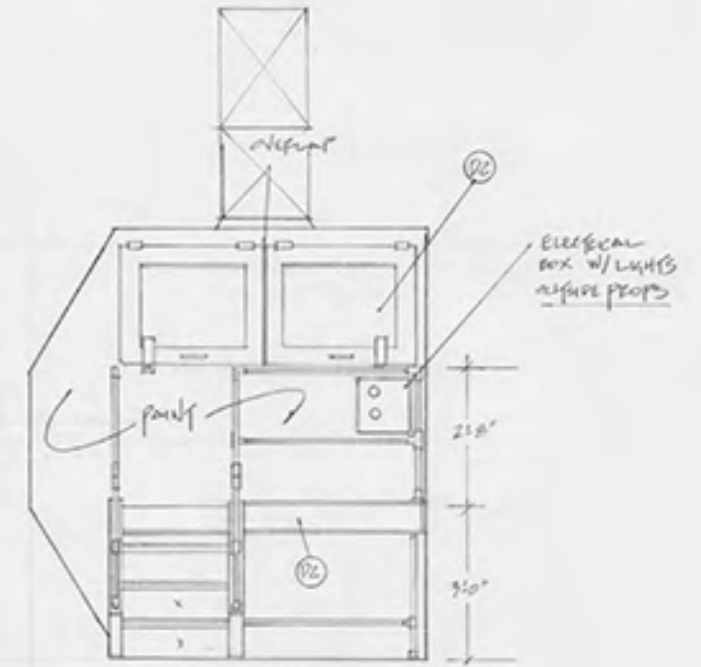

D EXTERIOR
SCALE 1/2" = 1'-0"

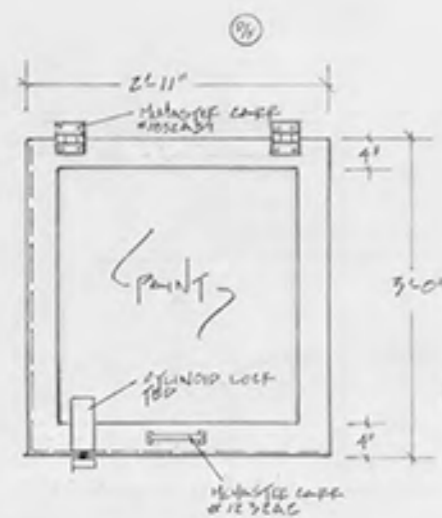
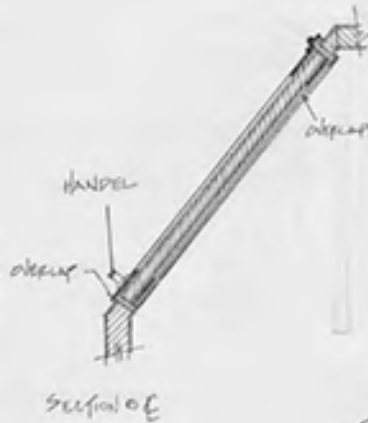

P1 DOOR DETAIL
SCALE 1" = 1'-0"

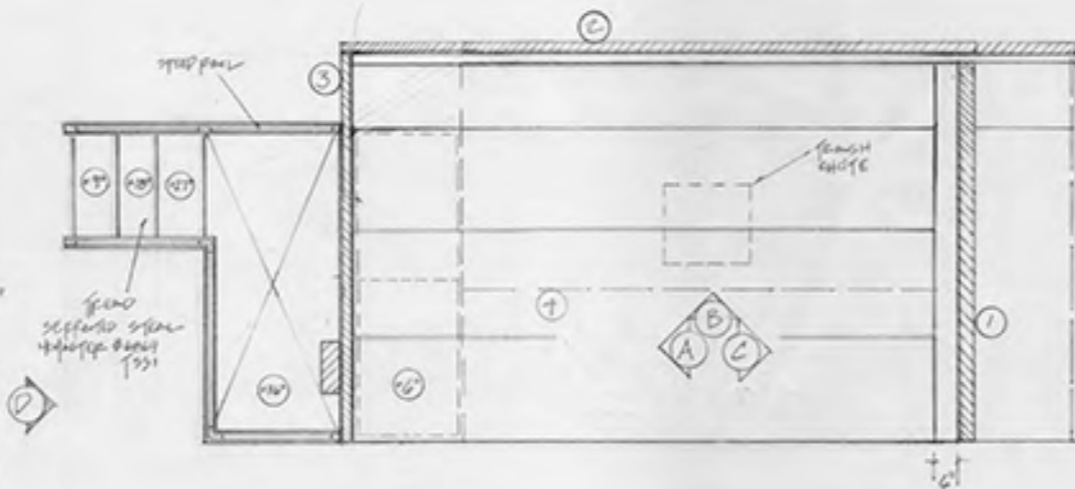

P PLAN
SCALE 1/2" = 1'-0"

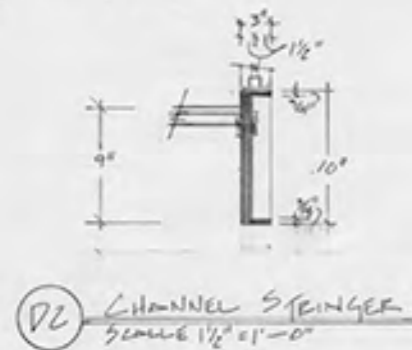

P2 CHANNEL SPINGER
SCALE 1 1/2" = 1'-0"

UNION STAMP S.D. 1104 SCENIC DESIGNER HPZ	AMERICAN BROADCASTING COMPANIES abc		DRAWING NO. /	
	PROJ: ONE LIFE TO LIVE		STUDIO 17	
	SET: TROUGH COMPACTOR			OR 1
	SCALE: 1/2" = 1'-0"	DEL DATE: 2-7-02		
	DRAWN DATE: 1/19/01	PROD DATE: 2-5-02		
DESIGNER: F. MOONEY		DRAFTSMAN: M. PAPER		

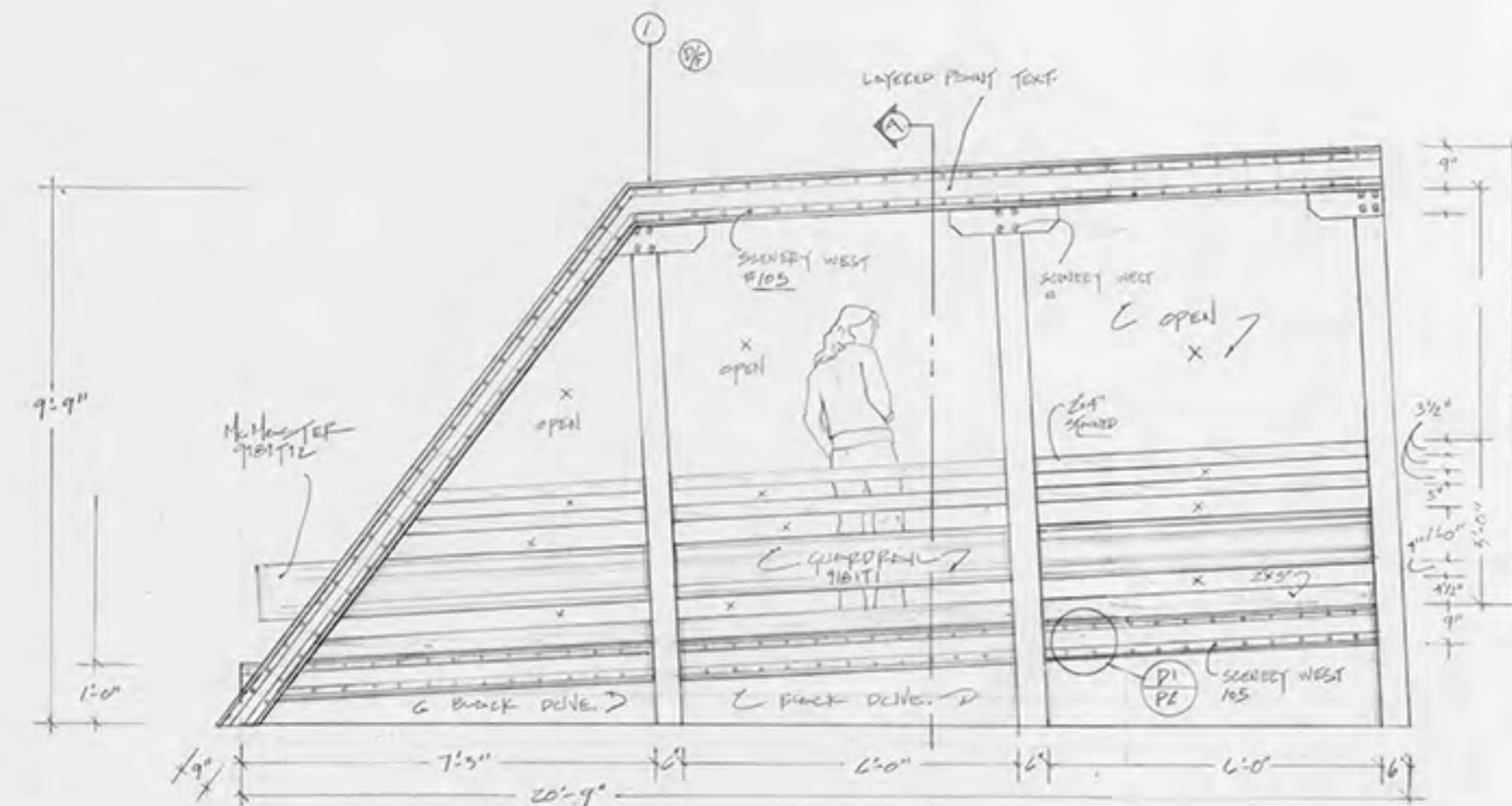

A VS BRIDGE FRONT
SCALE 1/2" = 1'-0"

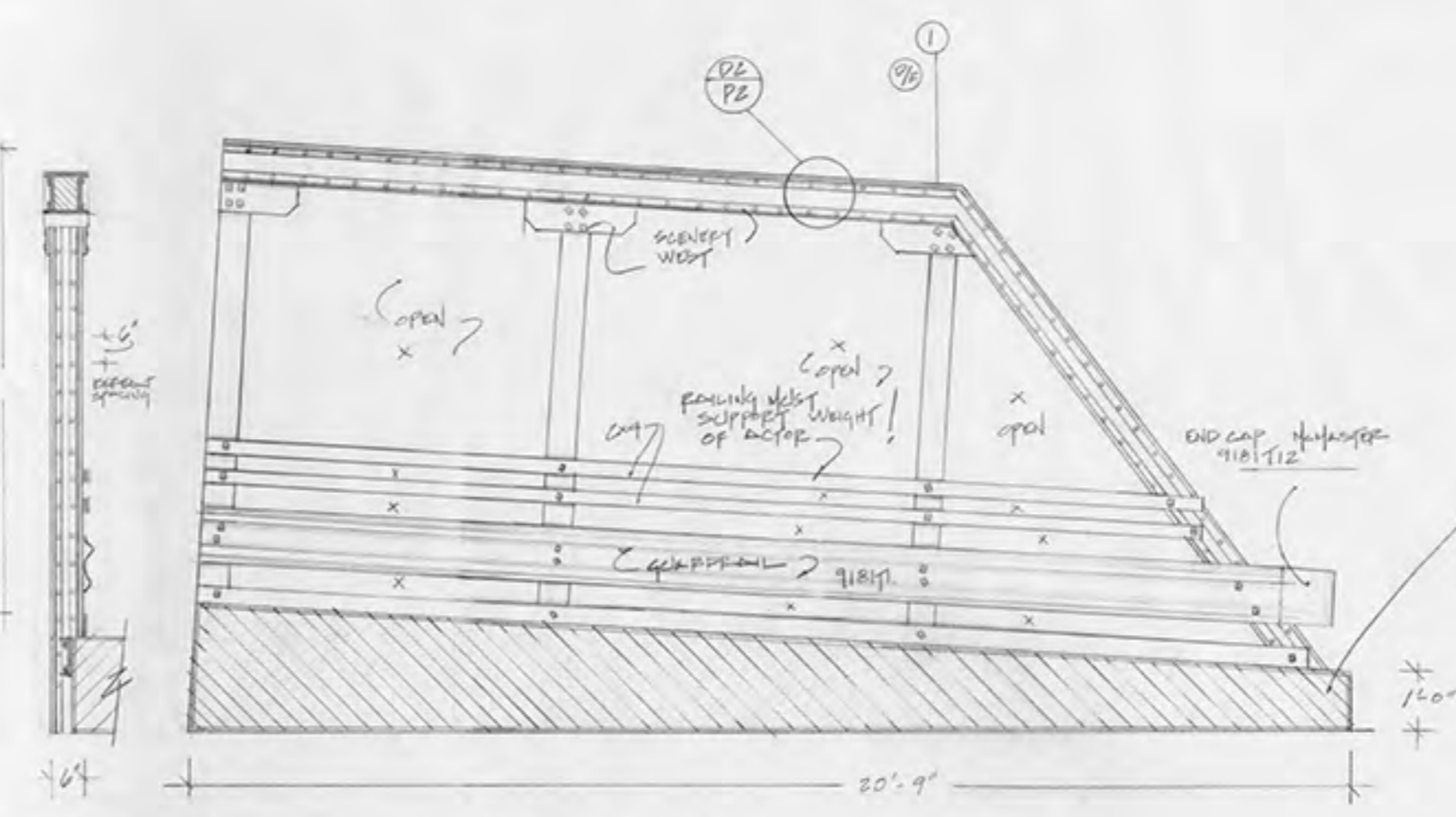

B PS BRIDGE INSIDE
SCALE 1/2" = 1'-0"

NOTE:
PLATEWALK MUST SUPPORT
WEIGHT OF CAP

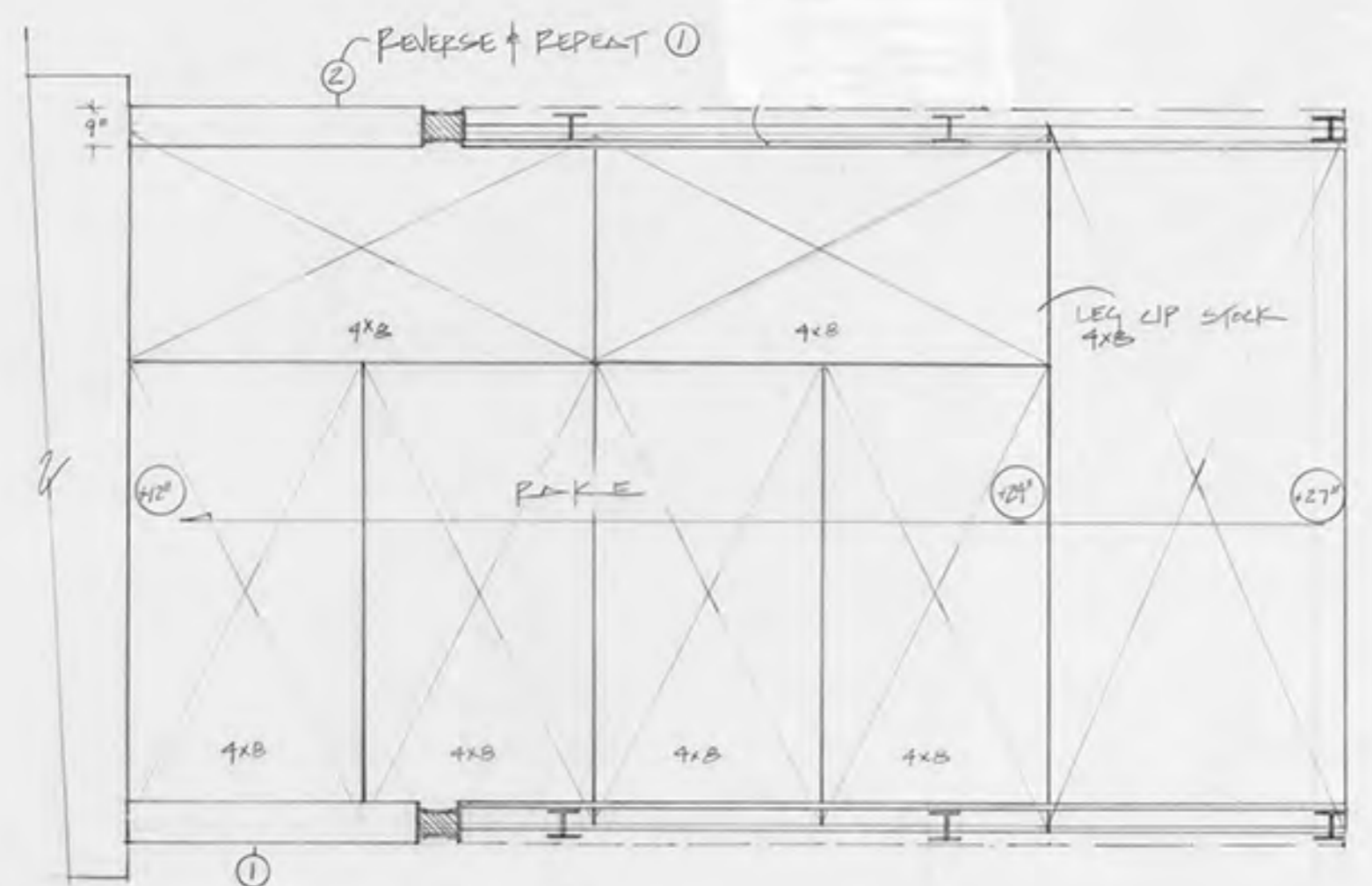

PLAN

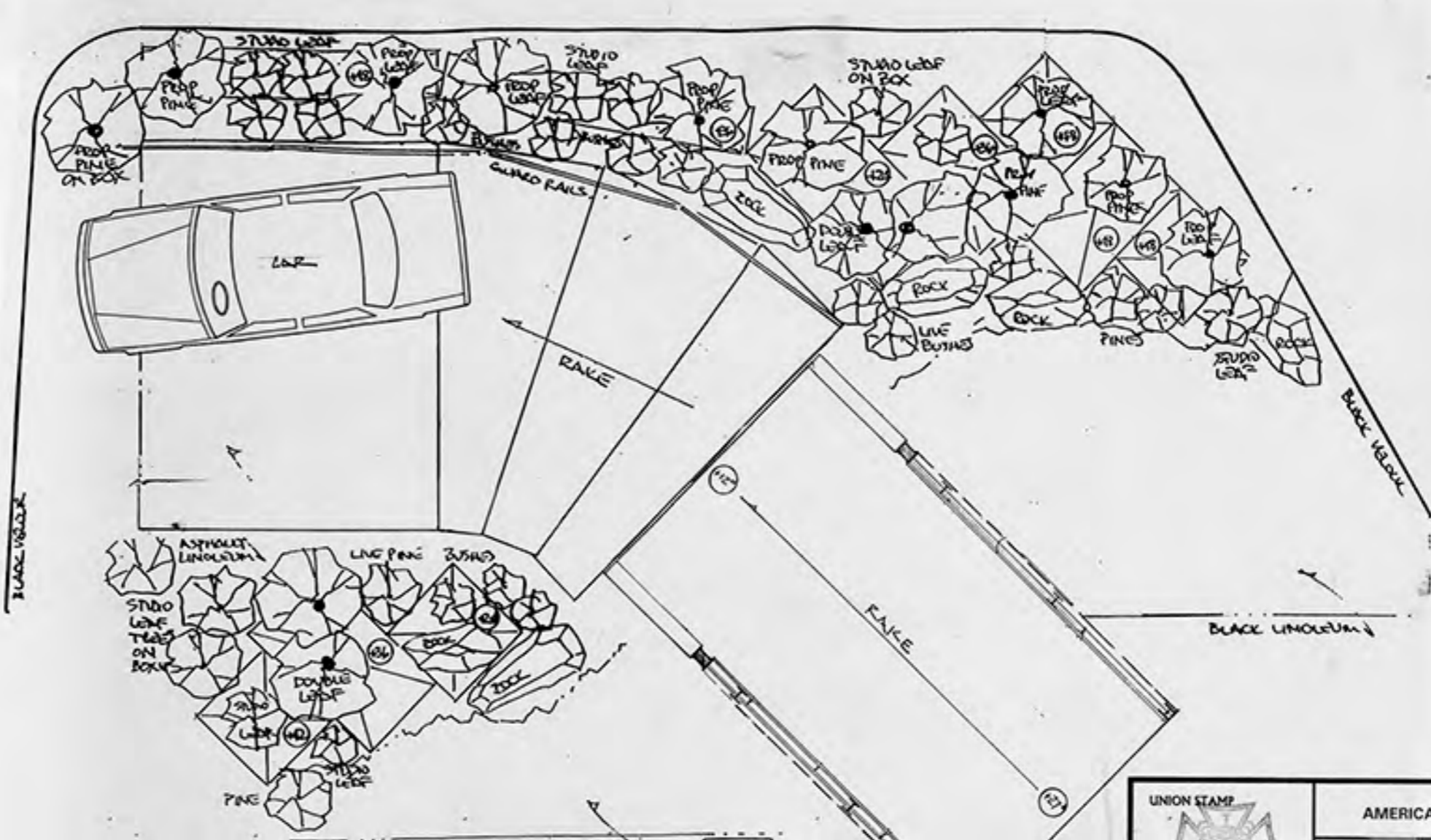

REFLECTOR PAINT
BLACK LINOLEUM
REFLECTOR PAINT

BRIDGE

REVISED
6-10-02

dumped June 02

UNION STAMP S.D. 1104 SCENIC DESIGNER	AMERICAN BROADCASTING COMPANIES abc		DRAWING NO.
	PROD: ONE LIFE TO LIVE	STUDIO 17	1 OF 2
	SET: BRIDGE	DEL. DATE: 6-21-02	
	SCALE: 1/2" = 1'-0"	PROD. DATE: 6-21-02	
	DATE: 6-6-02	DESIGNER: HOOLEY	DRAFTSMAN: FALTER

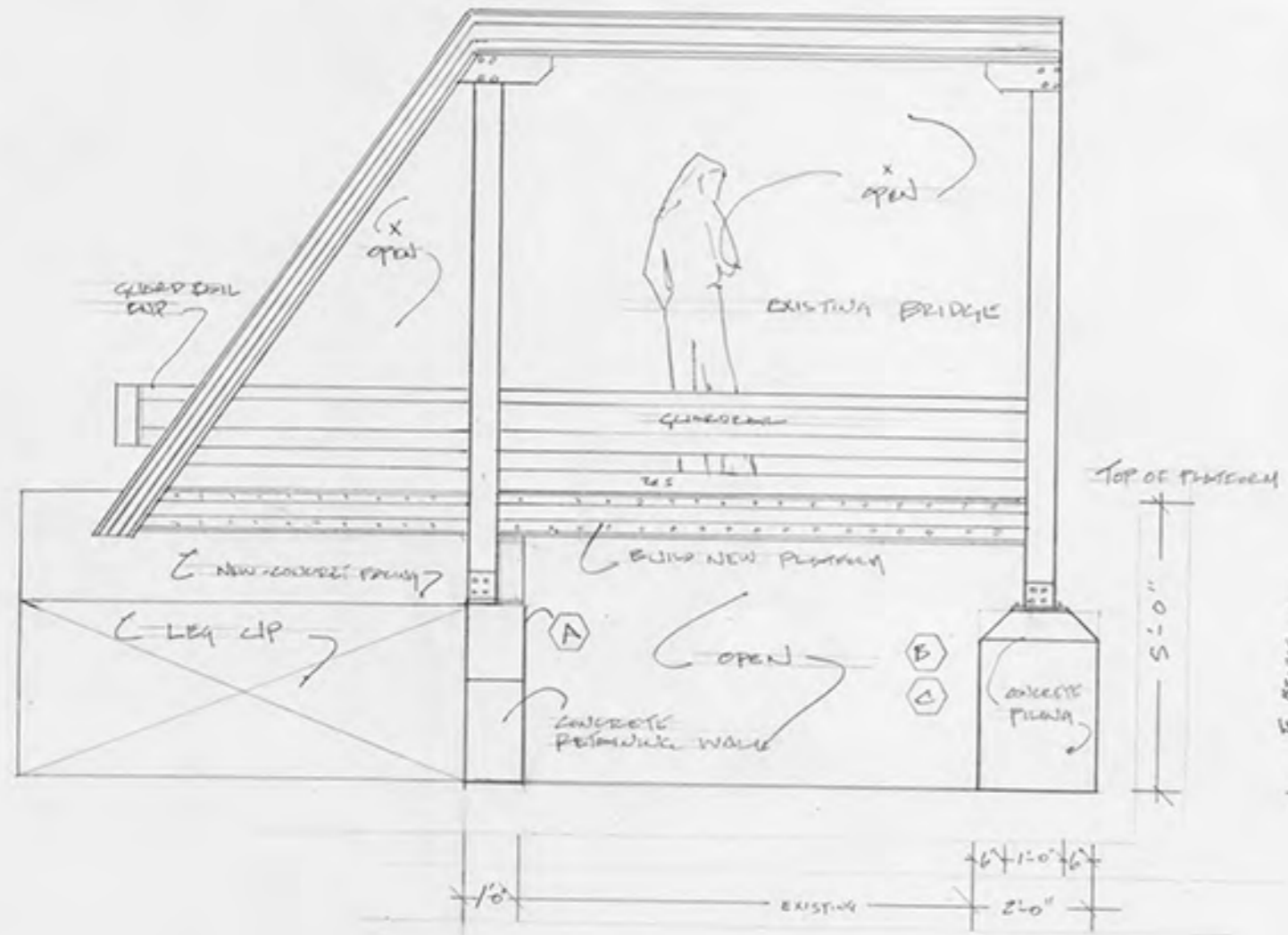

BRIDGE SIDE VIEW
SCALE 1/2"=1'-0"

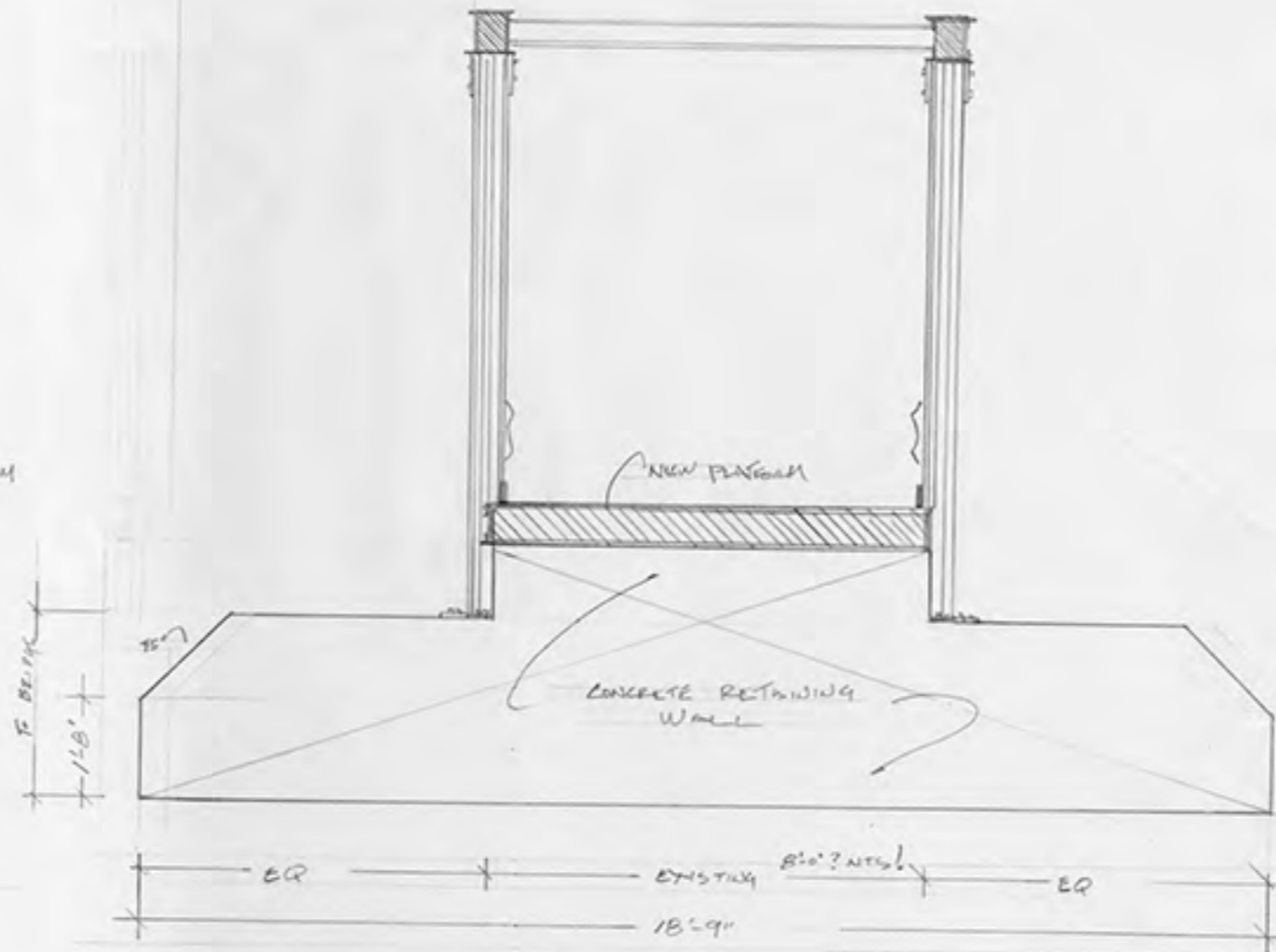

RETAINING WALL
SCALE 1/2"=1'-0"

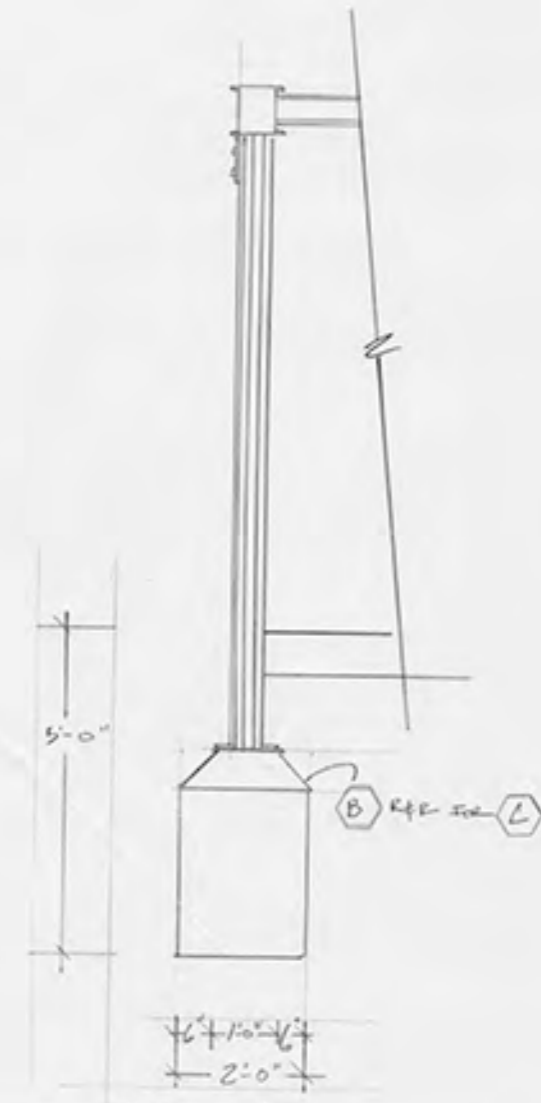

PILING
SCALE 1/2"=1'-0"

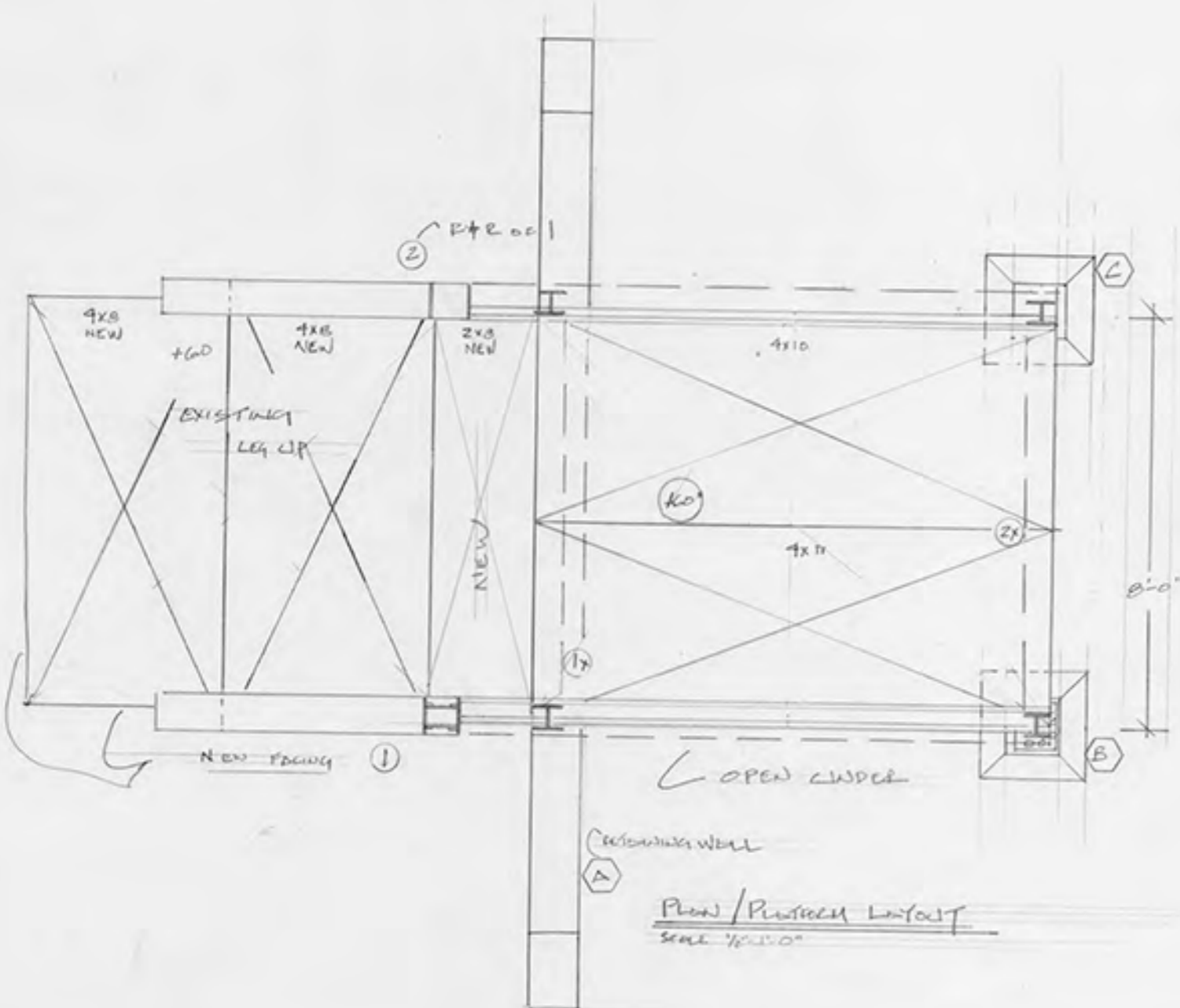

Plan/Profile Layout
SCALE 1/2"=1'-0"

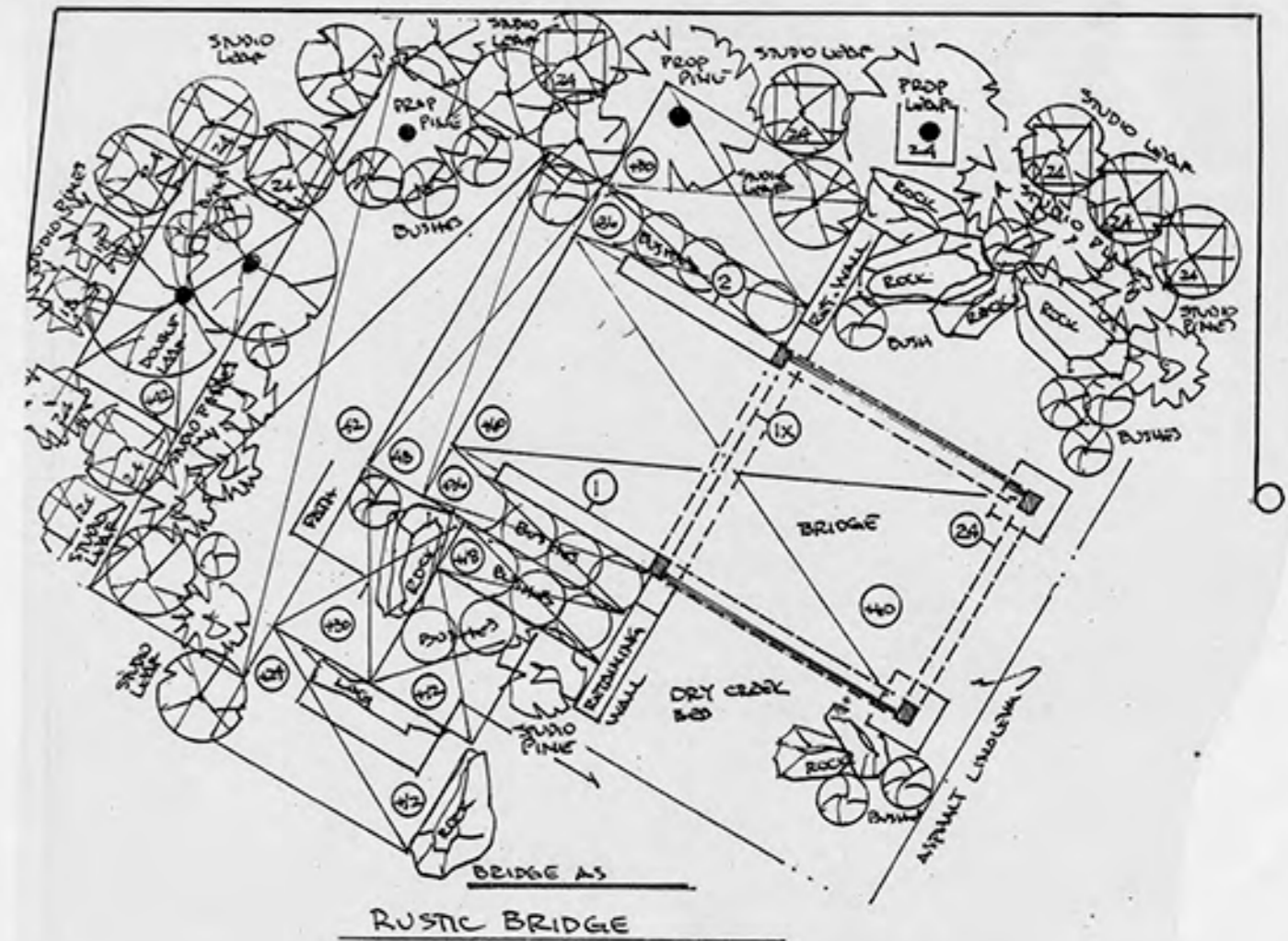

BRIDGE AS RUSTIC BRIDGE

UNION STAMP	AMERICAN BROADCASTING COMPANIES		DRAWING NO.
	PROD: ONE LIFE TO LIVE	STUDIO 17	
	SET: RUSTIC BRIDGE		
	SCALE: 1/2"=1'-0"	DEL. DATE: 6-4-07	
	DRAWN: 5-24-07	PROD. DATE: 6-5-07	
DESIGNER: R. MOKYF	DRAFTSMAN: R. FARRON		OF 1

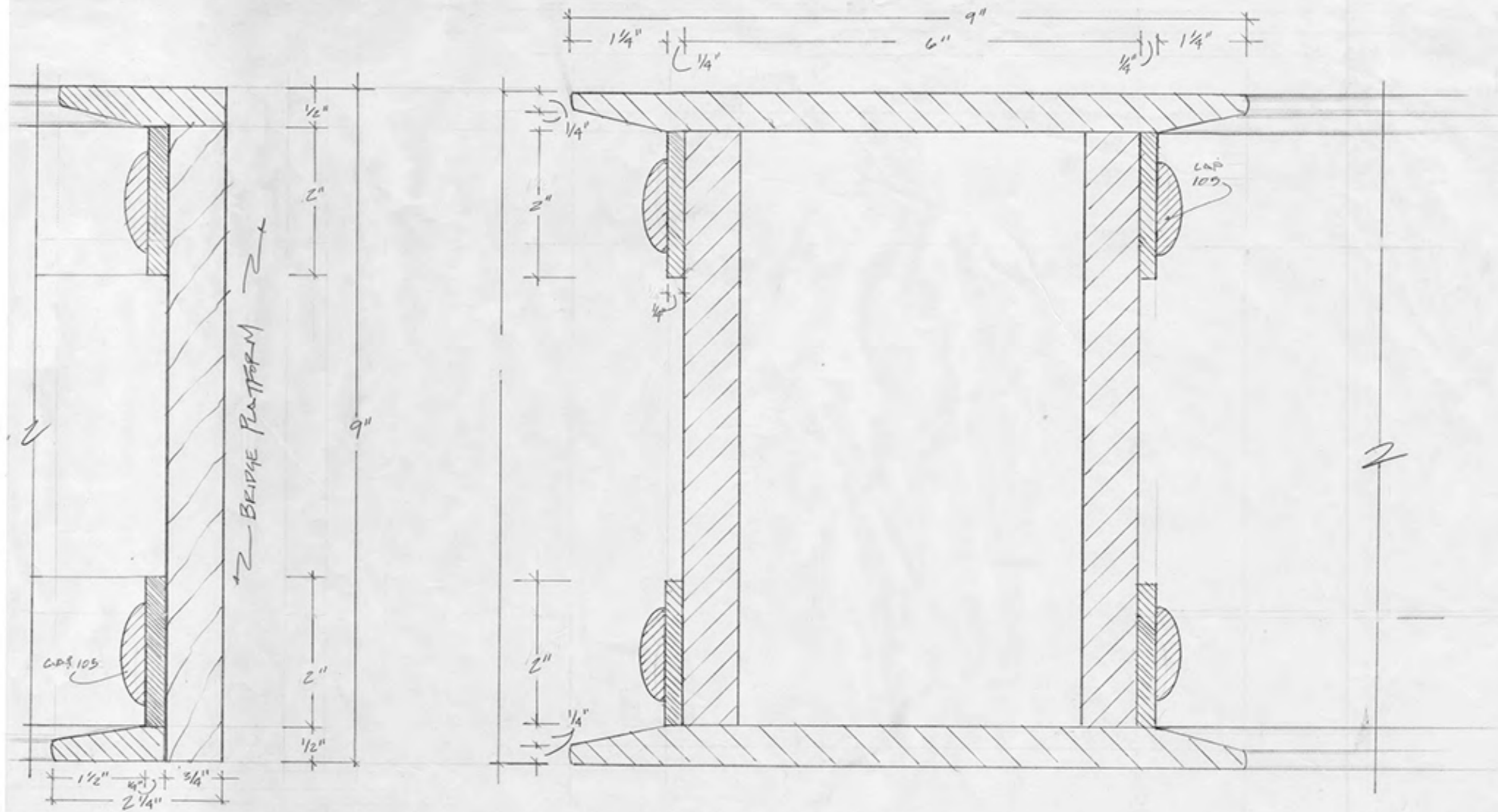

P1 Platform Facing Detail
FULL SCALE

P2 I BEAM DETAIL
FULL SCALE

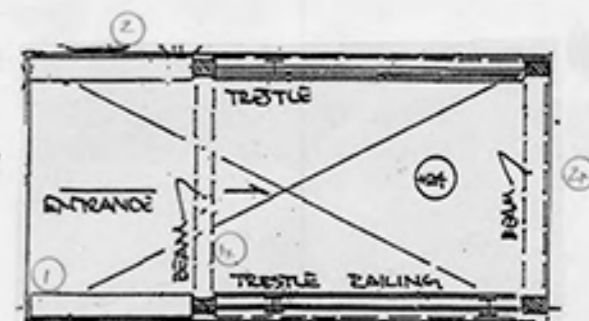

BLACK COPY

BRIDGE

UNION STAMP S.D. 1104 SCENIC DESIGNER 	AMERICAN BROADCASTING COMPANIES		DRAWING NO.
	PROD: ALL MY CHILDREN	STUDIO TV 23	2 OF 2
	SET: BRIDGE	SCALE: NOTED	
	DRAWN: 6-6	DEL. DATE: 6-21-06	PROD. DATE: 6-22-06
	DESIGNER: MOONLET	DRAFTSMAN: FULBER	