

DOOR DETAIL

	<b>AMERICAN BROADCASTING COMPANIES</b>		DRAWING NO.
	PROD.: ALL MY CHILDREN	STUDIO 23	OF 3
	SET: P.V. JAIL CELL	SCALE: 1/2" = 1'-0"	
	DRAWN: 1-12-05	DEL. DATE: 2/3/05	PROD. DATE: 2/4/05
	DATE: 1-12-05	DESIGNER: R. MOLEY	DRAFTSMAN: M. FARRER

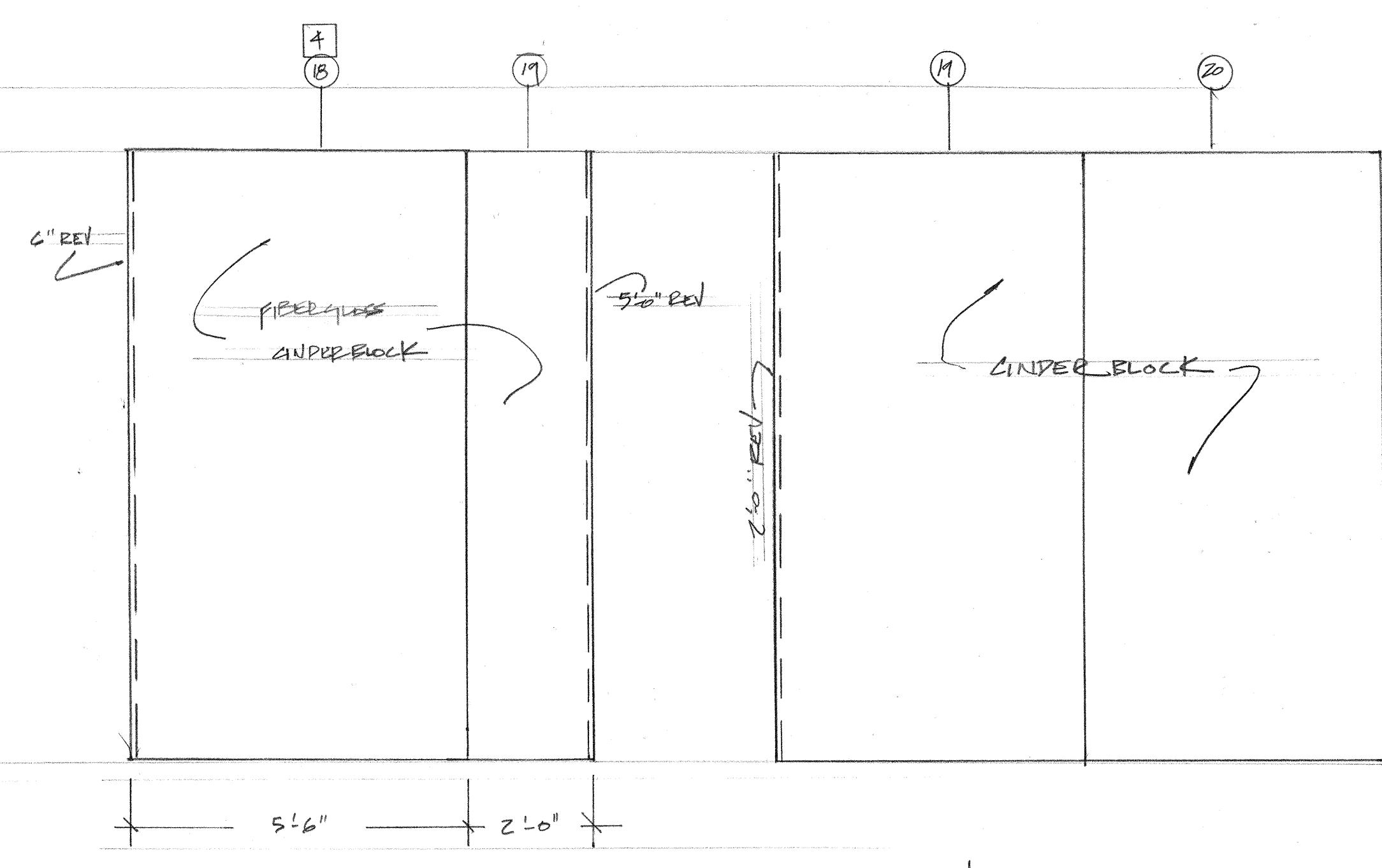
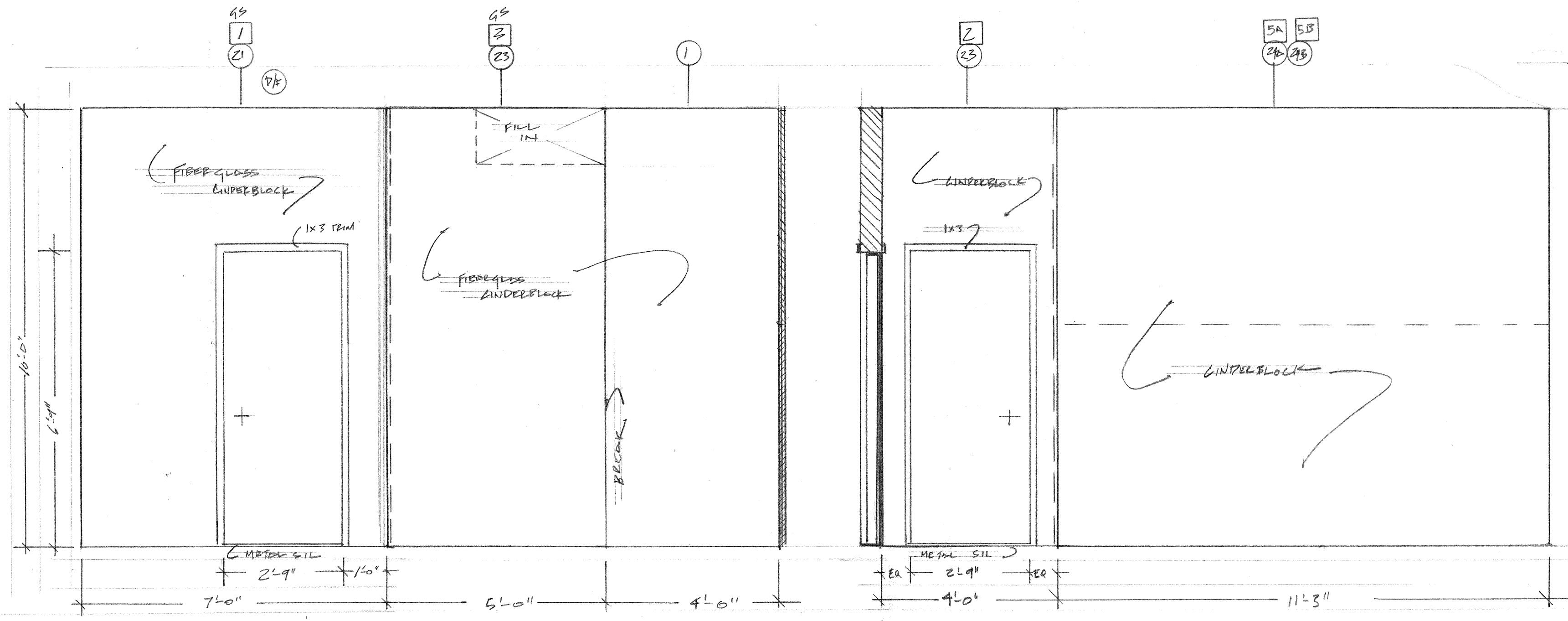

**A** SR HALLWAY  
SCALE 1/2"=1'-0"

**B** JAIL HALLWAY  
SCALE 1/2"=1'-0"

**C** JAIL CELL HALL BACKING  
SCALE 1/2"=1'-0"

**D** HALL BACKING  
SCALE 1/2"=1'-0"

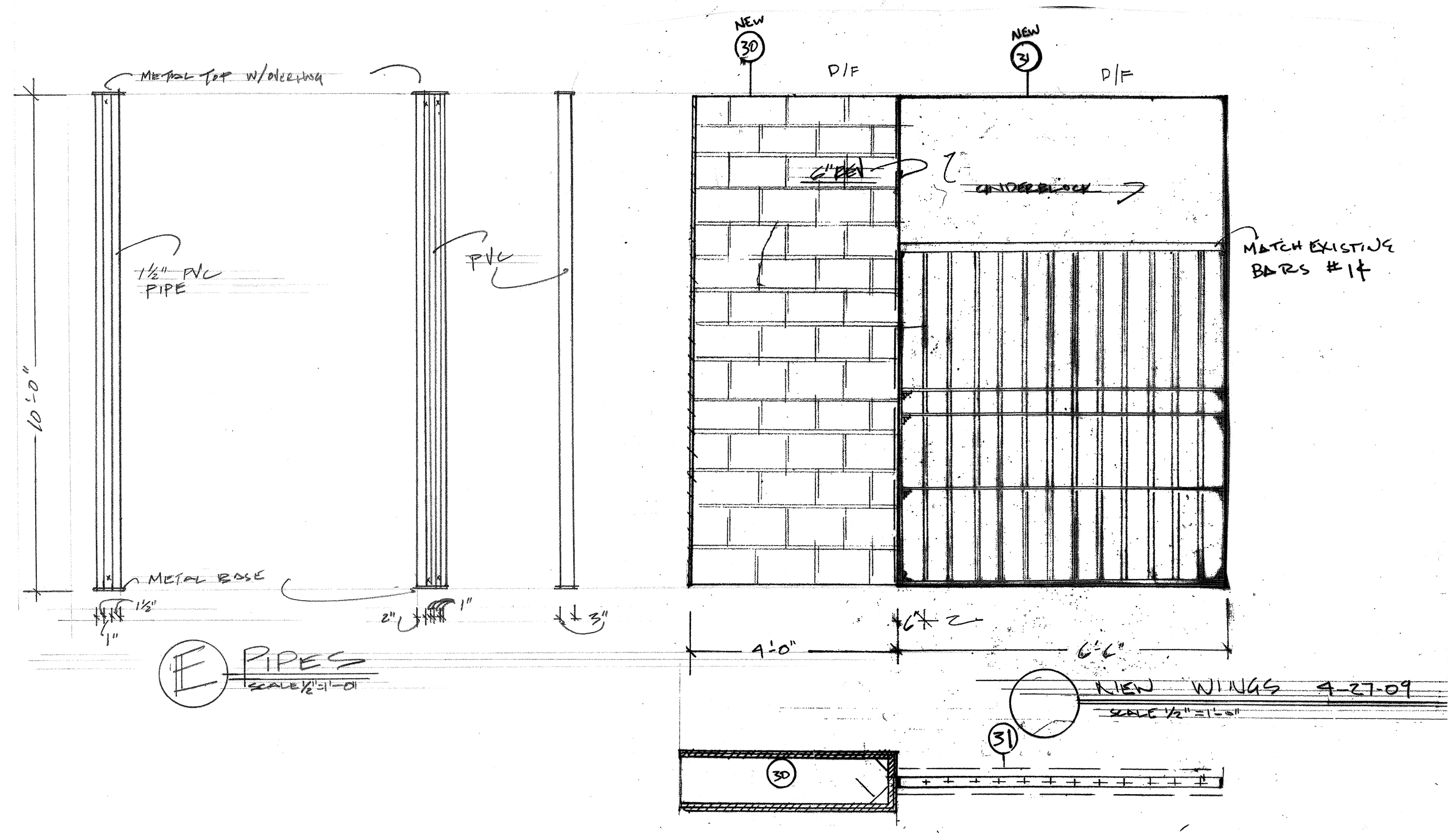
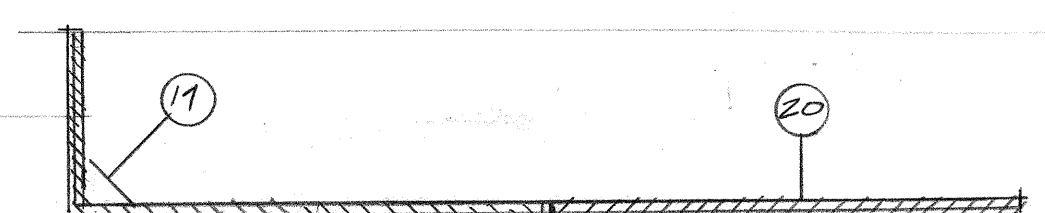
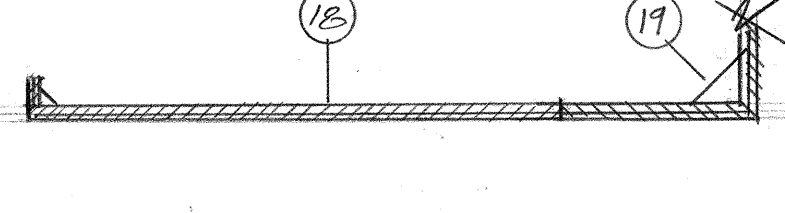
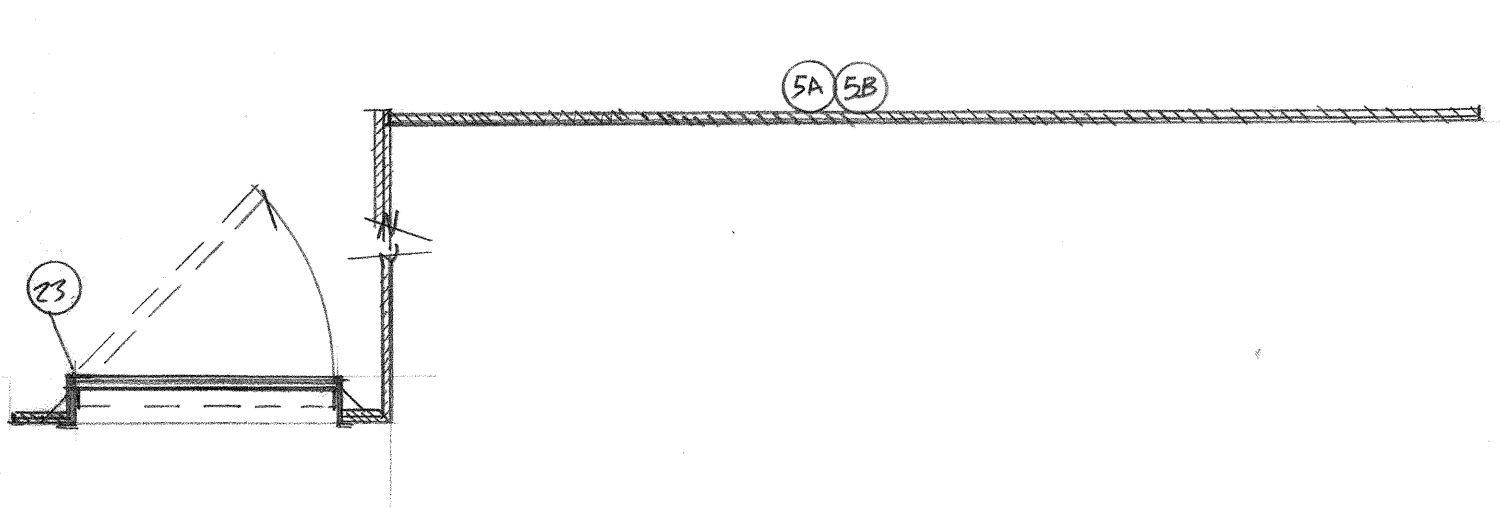
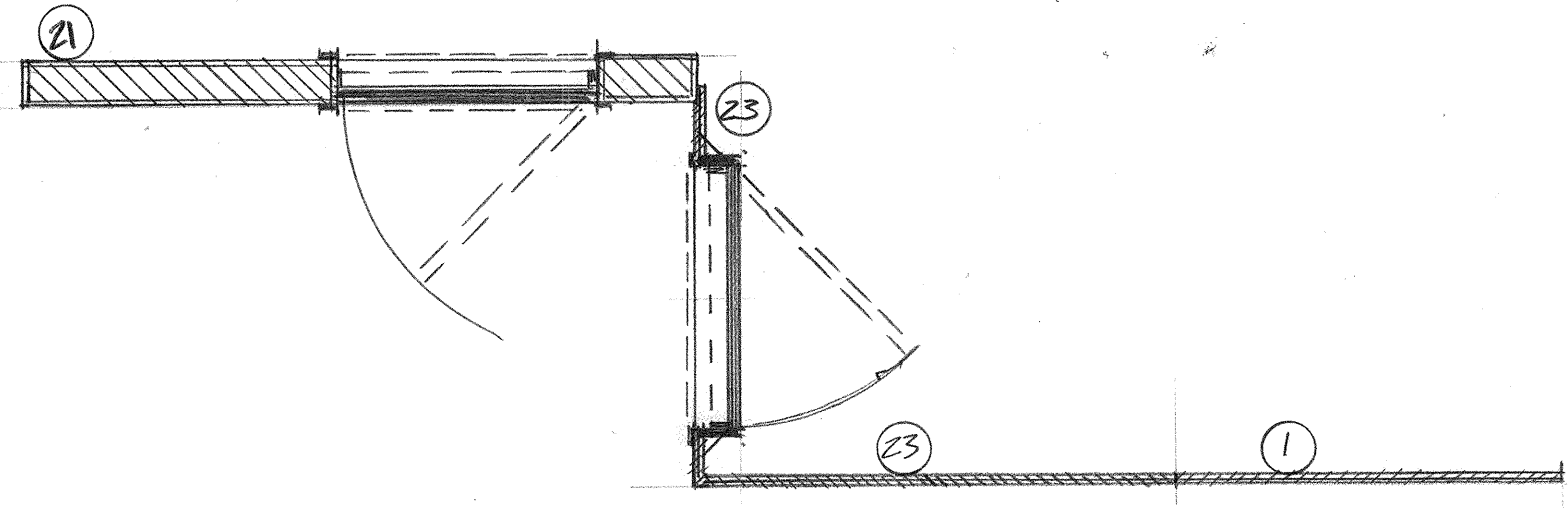

**E** PIPES  
SCALE 1/2"=1'-0"

NEW WINGS 9-21-09  
SCALE 1/2"=1'-0"

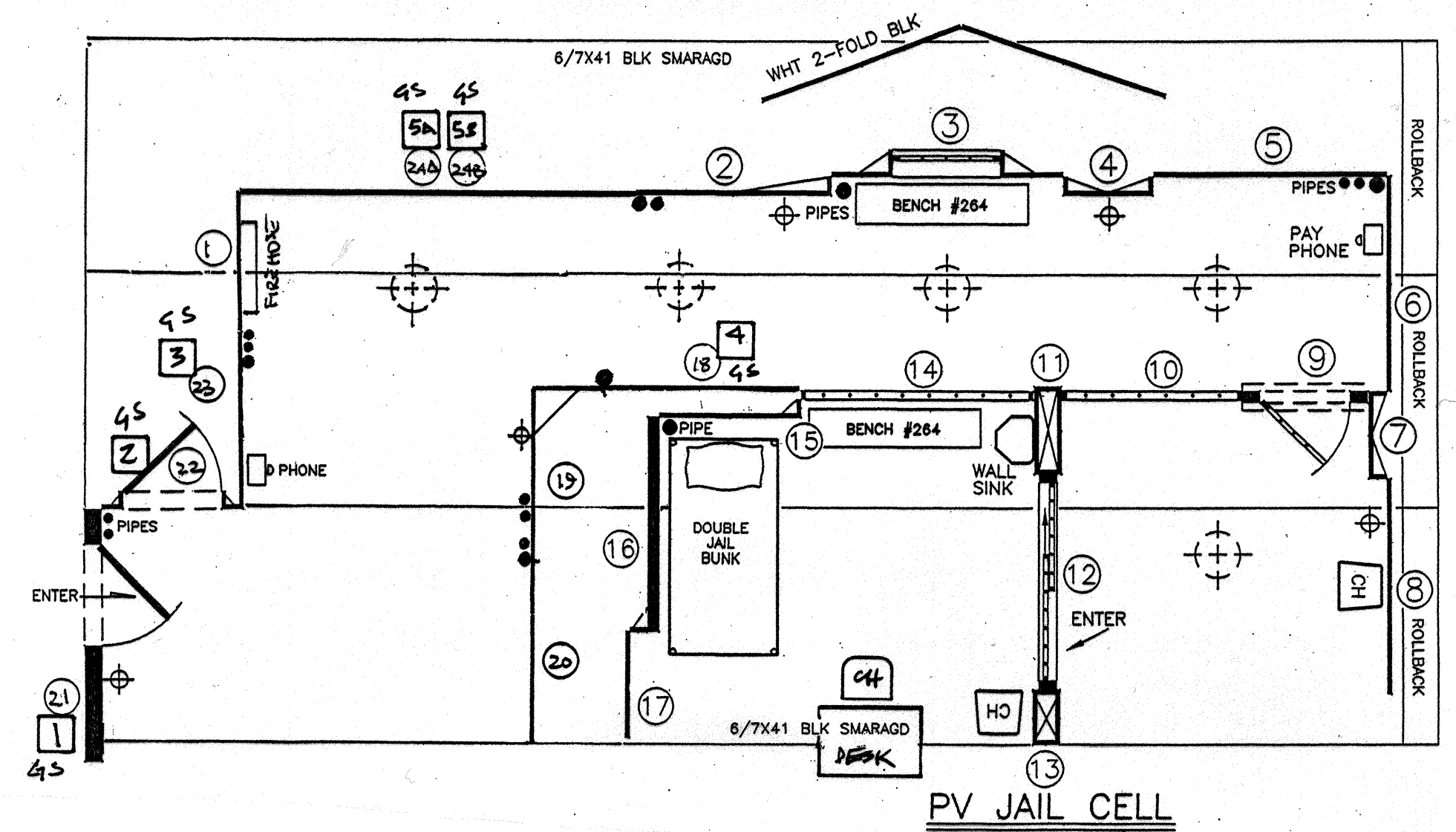

PV JAIL CELL

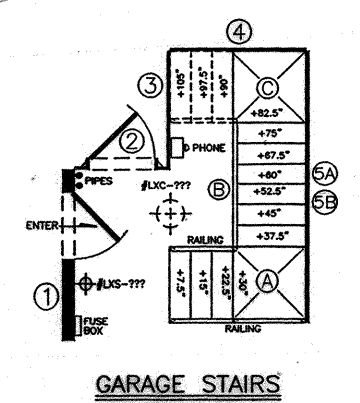

GARAGE STAIRS

<p>S.D. 1104 SCENIC DESIGNER M.F.</p>	<b>AMERICAN BROADCASTING COMPANIES</b> abc		DRAWING NO.	
	PROD.: <i>ALL MY CHILDREN</i> STUDIO TV 23		2	
	SET: <i>PV. JAIL CELL</i>			
	SCALE: 1/2"=1'-0"	DEL. DATE: 8-22-05		OF 3
	DRAWN: 8-12-05	PROD. DATE: 8-23-05		
DESIGNER: R. MOONEY	DRAFTSMAN: M. FAHRER			

